

EST™

Wet Odor Control Scrubber Systems

Severn Trent Services - EST WET ODOR CONTROL SCRUBBERS are engineered to treat malodorous gases emanating from municipal and industrial wastewater treatment facilities.

The Type "SOS" - SideWinder Odor Scrubber™ - is a low-profile, multistage, packaged system capable of treating air rates from 250 to 20,000 CFM. Larger air flow rates up to 65,000 CFM will be accommodated by the Type "VPT" - Vertical Packed Tower scrubber systems. All systems are fabricated from industrial grade fiberglass reinforced plastic - FRP - with internal corrosion barriers and external UV inhibitors.

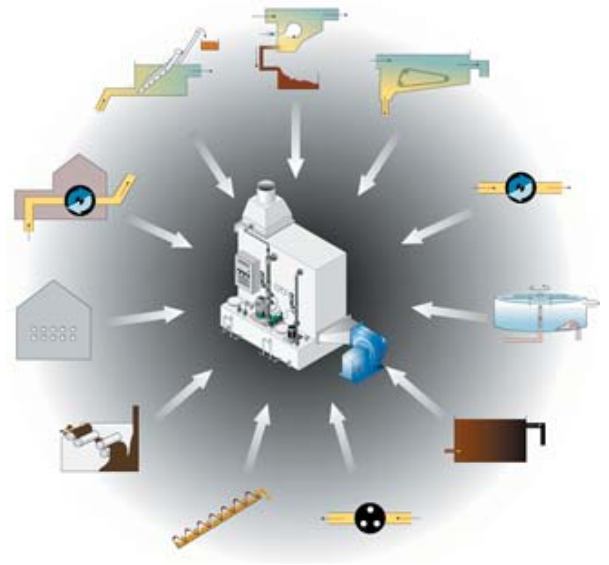

- **Low Profile Design**
- **Low Installation Costs**
- **Efficient Co-Current and Counter-Current Flow**
- **No Gas Bypassing**
- **99.9% H₂S Removal**
- **Low Chemical Fluid Pressure**
- **Fan-Driven**
- **Multiple Stages / Reduced Chemical Usage and Spent Chemical Treatment**
- **Low Cost Caustic and Bleach Scrubbing Solutions**
- **Unitized Construction with Automatic Controls**



TYPE SOS AND TYPE VPT - WET ODOR CONTROL SCRUBBER SYSTEMS

Type SOS

Sidewinder Odor Scrubber

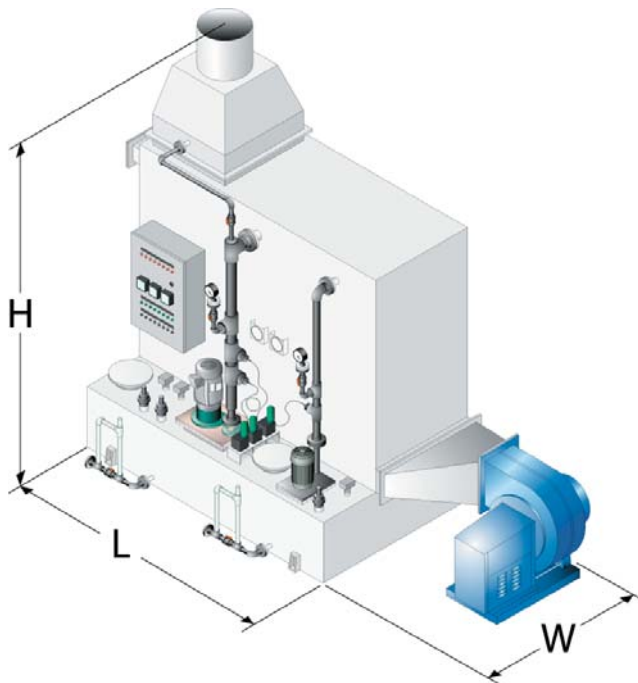

The Type SOS - SideWinder Odor Scrubber™ - is a low profile multistage gas absorption system for capacities to 20,000 cfm. The system contains two or more sumps for use of two or more chemical solutions to treat odors emanating from wastewater treatment plants, composting sites, and other industrial sites that generate odors. Caustic and bleach solutions treat hydrogen sulfide (H₂S) and other sulfur bearing compounds, indoles, skatoles, and other organic compounds. Sulfuric acid solutions treat ammonia, amines, and other basic compounds.

The system is complete with multiple contact stages, integral sumps, preassembled internals, chemical recirculation and metering pumps, pH and ORP instrumentation, NEMA 4X control panel, system fan, inlet duct transition, and exhaust stack.

Model SOS Size CFM	Dimensions (Feet)			Weight (lbs)	Horsepower	
	L	W	H		Pump	Fan
250	5.50	2.50	8.00	1500	7.5	no fan
500	5.50	3.00	10.00	1500	3	2
750	5.50	3.00	10.00	1800	3	2
1000	6.00	4.00	10.00	2200	3	3
2000	7.50	5.00	10.00	3000	5	5
3000	9.00	6.00	10.00	4000	5	7.5
4000	10.50	6.00	11.00	5000	5	7.5
5000	12.00	7.00	11.00	6000	7.5	7.5
7500	13.50	7.50	11.00	7500	7.5	15
10000	15.00	8.00	12.00	9000	10	15
15000	16.50	8.00	12.00	10000	10	25
20000	21.00	9.50	12.50	12000	10	30

The model size numbers indicate the scrubber exhaust rate in CFM. Weight is based on an empty single fan system.

Footprint dimensions "L" & "W" do not include the fan dimension.

Type VPT

Vertical Packet Tower Odor Scrubber

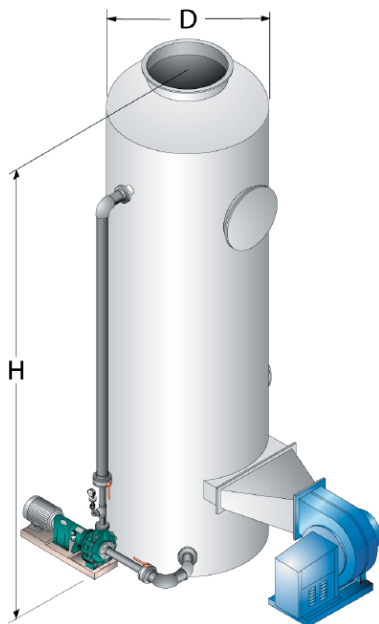

The Type VPT - Vertical Packed Tower - is the standard vertical, counter-current packed tower scrubber system for large flows of gas, normally larger than 20,000 cfm capacity. Again, multiple stages in series can be provided to make possible the use of multiple scrubbing solutions. On-site bleach generation systems can also be provided to electrolytically produce the sodium hypochlorite (NaOCl) scrubbing solution.

Model VPT Size CFM	Dimensions (Feet)				Weight (lbs)	Horsepower	
	D	H	L	W		Pump	Fan
13000	6.00	22	8	10	5000	7.5	20
18000	7.00	25	9	11	6000	10	30
25000	8.00	27	10	12	7000	15	40
30000	9.00	28	12	14	8000	15	50
35000	10.00	28	12	15	10000	20	60
45000	11.00	28	13	16	12000	25	60
55000	12.00	28	15	16	14000	30	100
65000	13.00	28	15	17	15000	40	125

The model size numbers indicate the scrubber exhaust rate in CFM. Weight is based on an empty single fan system.







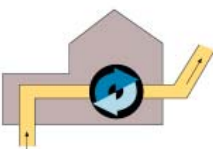
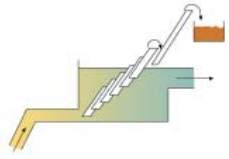

Footprint dimensions "L" & "W" do not include the fan dimension.

For applications where a wet scrubber is not desired, refer to Bulletin 575.0010 for "Dry Scrubbers" available from STS/EST.

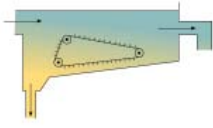
WET ODOR SCRUBBER SYSTEMS - APPLICATION DATA SHEET

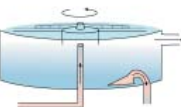
Make a copy of this form and submit as much information as possible about your application. This will enable Severn Trent Services to provide the best evaluation and recommendation to fulfill your requirements. This is an inquiry only - not an order - and involves no obligation. Please fax this form to: (215) 997-4062 or e-mail to: marketing@severntrentservices.com

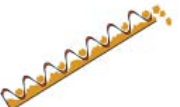
Contact Information		
Company _____	Phone () _____	Fax () _____
Address _____	E-mail _____	
Customer Contact _____	Reference No. _____	Date _____

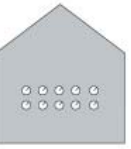
Inlet Gas Source, Typical Concentrations and Air Changes per Hour					
 PUMP/LIFT STATIONS 0-50 ppm H ₂ S 5 air changes/hr	 PRIMARY SCREENING CHAMBERS 50-500 ppm H ₂ S 10 air changes/hr	 GRIT CHAMBERS 50-500 ppm H ₂ S 25 air changes/hr	 PRIMARY SETTLING TANKS 50-500 ppm H ₂ S 10 air changes/hr	 WET WELLS-PUMP PITS 5-100 ppm H ₂ S 5 air changes/hr	
 CLARIFIERS 0-10 ppm H ₂ S 5 air changes/hr	 SLUDGE HOLDING TANKS 100-1000 ppm H ₂ S 10 air changes/hr	 SLUDGE THICKENERS 100-1000 ppm H ₂ S 10 air changes/hr	 SLUDGE CONVEYORS 0-10 ppm H ₂ S 10 air changes/hr	 PRESSURE FILTERS 0-50 ppm H ₂ S 10 air changes/hr	 CONTROL ROOMS 0-5 ppm H ₂ S 5 air changes/hr

Specify Gas Composition and Flow Rate			
Source	Component Odorous Gas	% Vol. or Inlet ppm	Removal Efficiency % or Outlet ppm

Inlet Gas Characteristics	
Overall air exhaust rate _____ CFM; Temperature _____ °F	
Combined inlet and outlet ducting losses _____ inches H ₂ O	
Solid particulates present <input type="checkbox"/> Yes <input type="checkbox"/> No; if yes, _____ type; inlet loading _____ grains/ft ³	
Optional Equipment and Design Features	
<input type="checkbox"/> Indoor Installation - room size restrictions _____ Height; _____ Width; _____ Length	
<input type="checkbox"/> Outdoor Installation - size restrictions _____ Height; _____ Width; _____ Length	
<input type="checkbox"/> Stand-by fan required	<input type="checkbox"/> Exhaust stack required
<input type="checkbox"/> Level gauge w/switches	<input type="checkbox"/> Sensor required in exhaust stack
<input type="checkbox"/> Materials of constructions	<input type="checkbox"/> Double wall
<input type="checkbox"/> Ductwork	<input type="checkbox"/> Heater
<input type="checkbox"/> Chemical storage tanks	<input type="checkbox"/> Thermal insulation
<input type="checkbox"/> Other (specify) _____	<input type="checkbox"/> On-site bleach generator
<input type="checkbox"/> Other _____	

Ask for other EST™ products available from Severn Trent Services



575.0001

Solids Conveyors

- Transport solids with gases or liquids
- Mix solids and liquids
- Handle slurries



575.0005

Emergency Scrubber Systems

- Protection against accidental gas releases
- Scrub Chlorine, Ammonia and Sulfur Dioxide



575.0015

Eductors, Syphons & Mixers

- Liquid pumping, heating and mixing applications
- Liquid and gas motive source
- Specialized designs for erosive or corrosive applications



575.0020

Heaters

- Inline steam heating
- Tank steam heating
- Direct contact heaters
- Shell & tube heaters



575.0025

Exhausters & Compressors

- Liquid jet exhausters handle gases with liquid motive sources
- Gas jet compressors handle gases with gas motive sources



575.0030

Vacuum Systems

- Handle gases under vacuum using steam
- Multi-stage ejectors
- Non-condensing and condensing systems
- Shell & tube and direct contact condensers



575.0035

Desuperheaters

- Desuperheating steam
- Gas cooling
- Waste heat recovery



575.0040

Wet Scrubber Systems

- Ejector venturi scrubbers
- Packed tower scrubbers
- High energy scrubbers
- Packaged systems

Severn Trent Services

3000 Advance Lane
Colmar, PA 18915
Telephone 215 997 4000
Fax 215 997 4062
marketing@severntrentservices.com