

LONGTECH

ROOTS TYPE BLOWER

ROOTS TYPE BLOWER
LONGTECH

ROOTS

TYPE

LT AND LTV SERIES

BLOWER



QUANGMINH

www.quangminhvn.com



PROFILE

LONGTECH Machinery Industry Co.Ltd. established since 1982, devoted to design and manufactures Three-Lobe Roots Type Blower. LONGTECH develops Twist Impeller Blowers (RTS/RTSV series) and High Speed Blowers (LTH/LTHS) in year 2013. LONGTECH sales blowers worldwide and win great satisfaction from our long-term cooperation customers and OEM partners.

In spite of competitive market, LONGTECH erect solid business position of Roots Type Blower manufacturing, we have OEM and ODM ability and qualified by ISO and CE.

VISION

Provide more competitive Roots Type Blowers, make win win with our customers.



QUANGMINH

www.quangminhvn.com

LONGTECH Roots Type Blower

LONGTECH Roots Type Blower is the innovative positive displacement rotary blower with straight three-lobe or twist three-lobe. All the main body, side cover and rotors machining by CNC and inspected by 3D instrument. Every each rotor qualified by dynamic balancing machine. Therefore, we keep our good quality of lower noise, lower vibration and stable performance.

LT/LTV Straight Three-Lobe Blower Feature

The three-lobe blower is less down pressure variation, vibration and noise, air flow is stable than Two-Lobe Blower. Also, save more power energy lost.

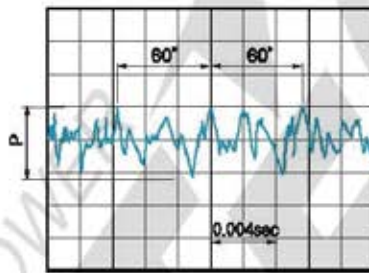

Pressure Fluctuation Curve

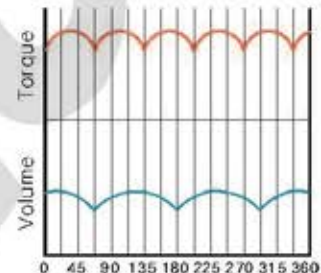

Discharge Pulsation Curve

RTS/RTSV Twist Three-Lobe Blower Feature

The three-lobe twist blower greatly reduced impulse, vibration and noise(5-8dB), and axial thrust by sucking and exhaling air without any pressure variation. Also, save more power energy lost.

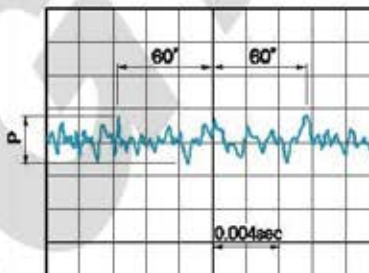

Pressure Fluctuation Curve

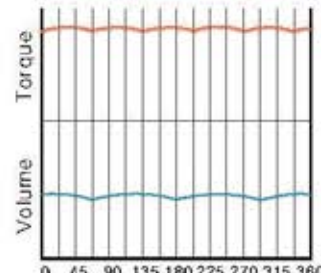

Discharge Pulsation Curve

Application Area

Wastewater Treatment

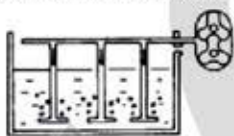

Particle Conveyance



Farming Pond

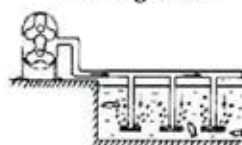

Cereal Products Conveyance

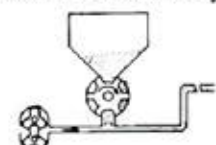

Air Supply for Electro bath

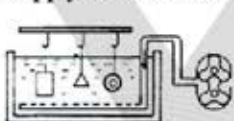

Paper Feeding

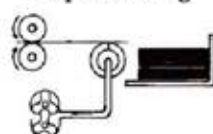

Absorption Transporter

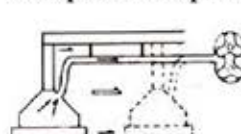

Vacuum Packing for Food

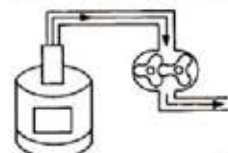

**Other application will not showing out. Please contact LONGTECH staff.

LONGTECH

Roots Type Pressure Blower Complete Set

Model

LT-040/RTS-040	LT-050/RTS-050	LT-065/RTS-065	LT-080/RTS-080	LT-100/RTS-100
LT-125S/RTS-125S	LT-125/RTS-125	LT-150/RTS-150	LT-200/RTS-200	LT-200A/RTS-200A
LT-250/RTS-250	LT-250A/RTS-250A	LT-300/RTS-300	LT-300A/RTS-300A	LT-350/RTS-350
LT-400/RTS-400				



Advantage

*Wider range for volume , pressure & horse power

*Bore 40mm to 500mm(1.5"to 20")

*Pressure:



Air Cooling Air Cooling and Water Cooling Water Cooling 2 Stage Blower with Water Cooling

**6000-8000mmAq cooling type depend at local temperature and blower model.

*Horse power : 0.5 to 1000HP

*Capacity : 0.5 to 560m³/min

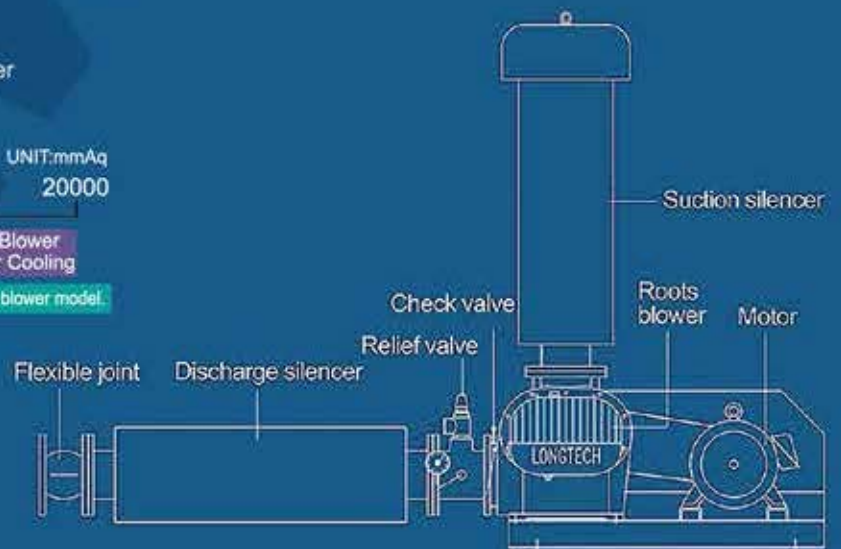

LONGTECH

Roots Type Vacuum Pump Complete Set

Model

LTV-040/RTSV-040	LTV-050/RTSV-050	LTV-065/RTSV-065	LTV-080/RTSV-080	LTV-100/RTSV-100
LTV-125S/RTSV-125S	LTV-125/RTSV-125	LTV-150/RTSV-150	LTV-200/RTSV-200	LTV-200A/RTSV-200A
LTV-250/RTSV-250	LTV-250A/RTSV-250A	LTV-300A/RTSV-300A	LTV-300/RTSV-300	LTV-350/RTSV-350
LTV-400/RTSV-400				

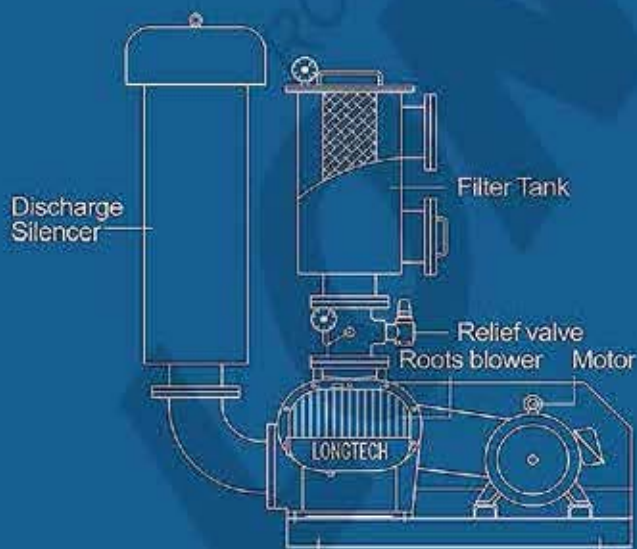

Advantage

*Wider range for volume , pressure & horse power

*Bore 40mm to 500mm(1.5"to 20")

*Vacuum:

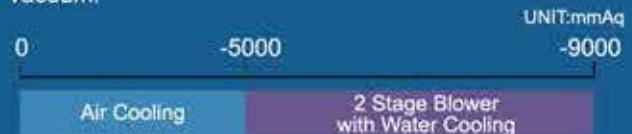

*Horse power : 0.5 to 700HP

*Capacity : 0.5 to 560m³/min



◆ **Gear(Timing):**

Forged steel gears with hardened and ground spur teeth to reduced vibrations and ensures accurate rotor to rotor timing for smooth and efficient operation.



◆ **Shaft:**

Shaft of Rotor is alloy steel forgings that allow higher operating pressures and rotation speeds.

◆ **Bearings:**

All LONGTECH Blower units are using SKF bearings for long life, Anti-friction efficiency is qualified.

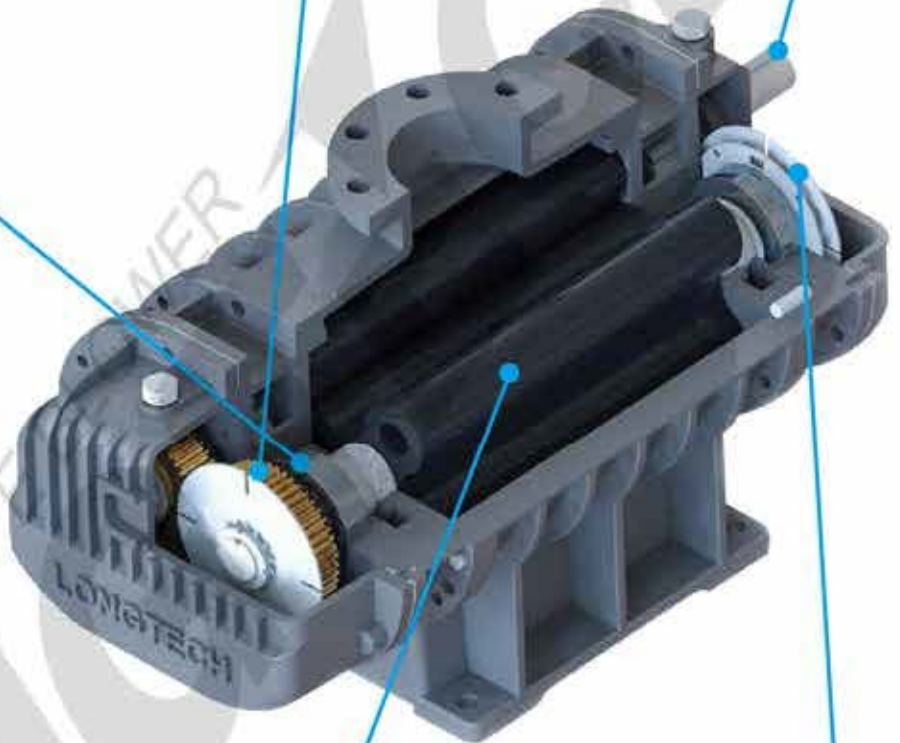

Twist Impeller

Straight Impeller

◆ **Impeller(Twist & Straight):**

Highest performance, providing with trouble-free performance and durability.

◆ **Seal:**

Lower-wear, non-contacting, labyrinth-type seals ensure performance and long life.



Roots Pressure Type of LT/RTS Performance Table

TYPE	RPM	PRESSURE(mmAq)																			
		1000		2000		3000		4000		5000		6000		7000		8000		9000		10000	
		m ³ /min	kW	m ³ /min	kW	m ³ /min	kW	m ³ /min	kW	m ³ /min	kW	m ³ /min	kW	m ³ /min	kW	m ³ /min	kW	m ³ /min	kW	m ³ /min	kW
040	1650	0.60	0.19	0.57	0.37	0.54	0.53	0.51	0.67	0.49	0.81	0.48	0.94								
	1800	0.68	0.21	0.64	0.40	0.61	0.57	0.59	0.74	0.57	0.88	0.55	1.02								
	1950	0.75	0.23	0.71	0.43	0.69	0.62	0.66	0.80	0.64	0.96	0.62	1.11								
	2100	0.83	0.24	0.79	0.47	0.76	0.67	0.74	0.86	0.71	1.03	0.70	1.19								
	2250	0.90	0.26	0.86	0.50	0.84	0.72	0.81	0.92	0.79	1.11	0.77	1.28								
	2400	0.97	0.28	0.94	0.53	0.91	0.77	0.88	0.98	0.86	1.18	0.85	1.36								
	2550	1.05	0.30	1.01	0.57	0.98	0.81	0.96	1.04	0.94	1.25	0.92	1.45								
050	850	0.99	0.41	0.79	0.80	0.64	1.16	0.50	1.51	0.38	1.84	0.29	2.15	0.21	2.45	0.15	2.74	0.08	3.02	0.02	3.28
	1000	1.31	0.48	1.11	0.94	0.96	1.37	0.82	1.77	0.70	2.16	0.61	2.53	0.53	2.88	0.47	3.22	0.41	3.55	0.34	3.86
	1150	1.63	0.56	1.44	1.08	1.28	1.57	1.15	2.04	1.02	2.49	0.93	2.91	0.86	3.32	0.79	3.71	0.73	4.08	0.66	4.44
	1300	1.95	0.63	1.76	1.22	1.61	1.78	1.47	2.31	1.34	2.81	1.25	3.29	1.18	3.75	1.12	4.19	1.05	4.61	0.99	5.02
	1450	2.27	0.70	2.08	1.36	1.93	1.98	1.79	2.57	1.67	3.13	1.58	3.67	1.50	4.18	1.44	4.67	1.37	5.15	1.31	5.60
	1600	2.60	0.77	2.40	1.50	2.25	2.19	2.11	2.84	1.99	3.46	1.90	4.05	1.82	4.61	1.76	5.16	1.69	5.68	1.63	6.18
	1750	2.92	0.85	2.72	1.64	2.57	2.39	2.43	3.11	2.31	3.78	2.22	4.43	2.14	5.05	2.08	5.64	2.01	6.21	1.95	6.76
065	850	2.07	0.62	1.89	1.21	1.71	1.76	1.55	2.29	1.41	2.78	1.29	3.26	1.19	3.71	1.09	4.15	0.63	4.71	0.51	5.20
	1000	2.58	0.73	2.41	1.42	2.22	2.07	2.07	2.69	1.93	3.27	1.81	3.83	1.71	4.37	1.60	4.88	1.11	5.54	0.99	6.12
	1150	3.10	0.84	2.93	1.64	2.74	2.38	2.58	3.09	2.45	3.77	2.33	4.41	2.22	5.03	2.12	5.62	1.60	6.37	1.48	7.03
	1300	3.62	0.95	3.45	1.85	3.26	2.69	3.10	3.50	2.96	4.26	2.84	4.99	2.74	5.68	2.64	6.35	2.09	7.20	1.97	7.95
	1450	4.13	1.06	3.96	2.06	3.77	3.01	3.62	3.90	3.48	4.75	3.36	5.56	3.26	6.34	3.15	7.08	2.58	8.03	2.46	8.87
	1600	4.65	1.17	4.48	2.28	4.29	3.32	4.13	4.30	4.00	5.24	3.88	6.14	3.77	6.99	3.67	7.81	3.06	8.86	2.94	9.79
	1750	5.17	1.28	5.00	2.49	4.81	3.63	4.65	4.71	4.51	5.73	4.39	6.71	4.29	7.65	4.19	8.55	3.55	9.69	3.43	10.70
080	850	3.24	1.12	2.87	2.14	2.54	3.08	2.23	3.94	1.95	4.73	1.70	5.47	1.48	6.15	1.28	6.79	1.03	7.48	0.84	8.24
	1000	4.14	1.32	3.77	2.52	3.44	3.62	3.13	4.63	2.85	5.57	2.60	6.44	2.38	7.24	2.18	7.99	1.93	8.80	1.74	9.70
	1150	5.04	1.51	4.67	2.90	4.34	4.16	4.03	5.33	3.75	6.40	3.50	7.40	3.28	8.33	3.08	9.19	2.83	10.12	2.64	11.15
	1300	5.94	1.71	5.57	3.27	5.24	4.71	4.93	6.02	4.65	7.24	4.40	8.37	4.18	9.41	3.98	10.39	3.73	11.44	3.54	12.61
	1450	6.84	1.91	6.47	3.65	6.14	5.25	5.83	6.72	5.55	8.07	5.30	9.33	5.08	10.50	4.88	11.58	4.63	12.76	4.44	14.06
	1600	7.74	2.11	7.37	4.03	7.04	5.79	6.73	7.41	6.45	8.91	6.20	10.30	5.98	11.58	5.78	12.78	5.53	14.08	5.34	15.52
	1750	8.64	2.30	8.27	4.41	7.94	6.33	7.63	8.11	7.35	9.75	7.10	11.26	6.88	12.67	6.68	13.98	6.43	15.39	6.24	16.97
100	850	5.80	1.57	5.19	3.00	4.65	4.31	4.16	5.51	3.74	6.63	3.36	7.66	3.03	8.62	2.74	9.51	2.44	10.60	2.15	11.54
	1000	7.06	1.84	6.45	3.53	5.91	5.07	5.42	6.49	5.00	7.80	4.62	9.01	4.29	10.14	4.00	11.19	3.70	12.47	3.41	13.58
	1150	8.32	2.12	7.71	4.05	7.17	5.83	6.68	7.46	6.26	8.97	5.88	10.36	5.55	11.66	5.26	12.86	4.96	14.34	4.67	15.62
	1300	9.58	2.40	8.97	4.58	8.43	6.59	7.94	8.43	7.52	10.14	7.14	11.71	6.81	13.18	6.52	14.54	6.22	16.22	5.93	17.65
	1450	10.84	2.67	10.23	5.11	9.69	7.35	9.20	9.41	8.78	11.31	8.40	13.06	8.07	14.70	7.78	16.22	7.48	18.09	7.19	19.69
	1600	12.10	2.95	11.49	5.64	10.95	8.11	10.46	10.38	10.04	12.47	9.66	14.42	9.33	16.22	9.04	17.90	8.74	19.96	8.45	21.73
	1750	13.36	3.23	12.75	6.17	12.21	8.87	11.72	11.35	11.30	13.64	10.92	15.77	10.59	17.74	10.30	19.57	10.00	21.83	9.71	23.76
125S	750	8.13	2.05	7.43	3.91	6.80	5.62	6.22	7.20	5.72	8.66	5.25	10.01	4.83	11.26	4.46	12.42	4.08	13.86	3.70	15.28
	900	10.02	2.46	9.32	4.70	8.69	6.75	8.11	8.64	7.61	10.39	7.14	12.01	6.72	13.51	6.35	14.91	5.97	16.63	5.59	18.33
	1050	11.91	2.86	11.21	5.48	10.58	7.87	10.00	10.08	9.50	12.12	9.03	14.01	8.61	15.76	8.24	17.39	7.86	19.40	7.48	21.39
	1200	13.80	3.27	13.10	6.26	12.47	9.00	11.89	11.52	11.39	13.85	10.92	16.01	10.50	18.01	10.13	19.88	9.75	22.17	9.37	24.44
	1350	15.69	3.68	14.99	7.04	14.36	10.12	13.78	12.96	13.28	15.58	12.81	18.01	12.39	20.27	12.02	22.36	11.64	24.94	11.26	27.50
	1500	17.58	4.09	16.88	7.83	16.25	11.25	15.67	14.40	15.17	17.31	14.70	20.01	14.28	22.52	13.91	24.85	13.53	27.71	13.15	30.55
	1650	19.47	4.50	18.77	8.61	18.14	12.37	17.56	15.84	17.06	19.04	16.59	22.01	16.17	24.77	15.80	27.33	15.42	30.48	15.04	33.61
125	750	10.29	2.59	9.42	4.96	8.62	7.13	7.88	9.12	7.25	10.97	6.66	12.67	6.11	14.26	5.65	15.74	5.16	17.55	4.69	19.35
	900	12.69	3.11	11.81	5.95	11.01	8.55	10.28	10.95	9.64	13.16	9.05	15.21	8.51	17.11	8.04	18.89	7.56	21.06	7.08	23.22
	1050	15.08	3.63	14.20	6.94	13.41	9.98	12.67	12.77	12.03	15.35	11.44	17.74	10.90	19.97	10.44	22.04	9.95	24.57	9.48	27.09
	1200	17.48	4.15	16.60	7.93	15.80	11.40	15.07	14.59	14.43	17.55	13.84	20.28	13.29	22.82	12.83	25.18	12.34	28.08	11.87	30.96
	1350	19.87	4.66	18.99	8.92	18.19	12.83	17.46	16.42	16.82	19.74	16.23	22.81	15.69	25.67	15.23	28.33	14.74	31.59	14.26	34.83
	1500	22.26	5.18	21.39	9.91	20.59	14.25	19.85	18.24	19.22	21.93	18.63	25.35	18.08	28.52	17.62	31.48	17.13	35.10	16.66	38.70
	1650	24.66	5.70	23.78	10.90	22.98	15.68	22.25	20.07	21.61	24.13	21.02	27.88	20.48	31.38	20.01	34.63	19.53	38.61	19.05	42.57
150	750	13.32	3.34	12.62	6.39	11.98	9.19	11.40	11.76	10.87	14.14	10.39	16.34	10.00	18.39	9.61	20.30	9.16	22.92	8.73	24.95
	900	16.40	4.01	15.70	7.67	15.06	11.03	14.49	14.11	13.95	16.97	13.48	19.61	13.09	22.07	12.70	24.36	12.25	27.50	11.81	29.94
	1050	19.49	4.68	18.79	8.95	18.15	12.86	17.58	16.47	17.04	19.80	16.57	22.88	16.18	25.75	15.78	28.41	15.33	32.09	14.90	34.93
	1200	22.58	5.35	21.88	10.23	21.24	14.70	20.66	18.82	20.13	22.62	19.65	26.15	19.26	29.42	18.87	32.47	18.42	36.67	17.99	39.92
	1350	25.66	6.02	24.96	11.50	24.33	16.54	23.75	21.17	23.21	25.45	22.74	29.42	22.35	33.10	21.96	36.53	21.51	41.26	21.07	44.91
	1500	28.75	6.68	28.05	12.78	27.41	18.38	26.84	23.52	26.30	28.28	25.83	32.69	25.44	36.78	25.05	40.59	24.59	45.84	24.16	49.90
	1650	31.84	7.35	31.14	14.06	30.50	20.21	29.92	25.88	29.39	31.11	28.91	35.96	28.52	40.46	28.13	44.65	27.68	50.43	27.25	54.89

Roots Pressure Type of LT/RTS Performance Table

TYPE	RPM	PRESSURE(mmAq)																			
		1000		2000		3000		4000		5000		6000		7000		8000		9000		10000	
		m ³ /min	kW	m ³ /min	kW	m ³ /min	kW	m ³ /min	kW	m ³ /min	kW	m ³ /min	kW	m ³ /min	kW	m ³ /min	kW	m ³ /min	kW	m ³ /min	kW
200	600	17.01	4.84	15.95	9.27	15.04	13.32	14.21	17.06	13.53	20.51	12.93	23.71	12.40	26.68	11.98	29.45	11.42	32.84	10.96	35.75
	750	22.68	6.05	21.62	11.58	20.71	16.65	19.88	21.32	19.20	25.64	18.60	29.64	18.07	33.36	17.65	36.81	17.09	41.05	16.63	44.682
	900	28.35	7.27	27.29	13.90	26.38	19.98	25.55	25.59	24.87	30.77	24.27	35.57	23.74	40.03	23.32	44.18	22.76	49.26	22.30	53.62
	1050	34.02	8.48	32.96	16.22	32.05	23.32	31.22	29.85	30.54	35.89	29.94	41.49	29.41	46.70	28.99	51.55	28.43	57.47	27.97	62.55
	1200	39.69	9.69	38.63	18.53	37.72	26.65	36.89	34.12	36.21	41.02	35.61	47.42	35.08	53.37	34.66	58.91	34.10	65.67	33.64	71.49
	1350	45.36	10.90	44.30	20.85	43.39	29.98	42.56	38.38	41.88	46.15	41.28	53.35	40.75	60.04	40.33	66.27	39.77	73.88	39.31	80.43
	1500	51.03	12.11	49.97	23.17	49.06	33.31	48.23	42.65	47.55	51.28	46.95	59.28	46.42	66.71	46.00	73.64	45.44	82.09	44.98	89.36
200A	600	27.72	7.40	26.22	14.16	24.89	20.35	23.68	26.06	22.58	31.34	21.60	36.23	20.73	40.77	19.98	45.00	18.77	50.17	17.96	54.61
	750	36.38	9.25	34.88	17.70	33.55	25.44	32.34	32.58	31.24	39.17	30.26	45.28	29.39	50.96	28.64	56.25	27.43	62.71	26.62	68.26
	900	45.05	11.10	43.54	21.24	42.22	30.53	41.00	39.09	39.91	47.01	38.92	54.34	38.06	61.15	37.31	67.50	36.09	75.25	35.29	81.92
	1050	53.71	12.95	52.21	24.77	50.88	35.62	49.67	45.61	48.57	54.84	47.59	63.39	46.72	71.34	45.97	78.75	44.76	87.79	43.95	95.57
	1200	62.37	14.80	60.87	28.31	59.54	40.71	58.33	52.12	57.23	62.67	56.25	72.45	55.38	81.54	54.63	90.00	53.42	100.34	52.61	109.22
	1350	71.03	16.65	69.53	31.85	68.20	45.80	66.99	58.64	65.89	70.51	64.91	81.51	64.04	91.73	63.29	101.24	62.08	112.88	61.27	122.9
	1500	79.70	18.50	78.19	35.39	76.87	50.89	75.65	65.16	74.56	78.34	73.57	90.56	72.71	101.91	71.96	112.49	70.74	125.42	69.94	136.5
250	600	27.72	7.40	26.22	14.16	24.89	20.35	23.68	26.06	22.58	31.34	21.60	36.23	20.73	40.77	19.98	45.00	18.77	50.17	17.96	54.61
	750	36.38	9.25	34.88	17.70	33.55	25.44	32.34	32.58	31.24	39.17	30.26	45.28	29.39	50.96	28.64	56.24	27.43	62.71	26.62	68.264
	900	45.05	11.10	43.54	21.24	42.22	30.53	41.00	39.09	39.91	47.01	38.92	54.34	38.06	61.15	37.31	67.50	36.09	75.25	35.29	81.92
	1050	53.71	12.95	52.21	24.77	50.88	35.62	49.67	45.61	48.57	54.84	47.59	63.39	46.72	71.34	45.97	78.75	44.76	87.79	43.95	95.57
	1200	62.37	14.80	60.87	28.31	59.54	40.71	58.33	52.12	57.23	62.67	56.25	72.45	55.38	81.54	54.63	90.00	53.42	100.34	52.61	109.22
	1350	71.03	16.65	69.53	31.85	68.20	45.80	66.99	58.64	65.89	70.51	64.91	81.51	64.04	91.73	63.29	101.2	62.08	112.88	61.27	122.9
	1500	79.70	18.50	78.19	35.39	76.87	50.89	75.65	65.16	74.56	78.34	73.57	90.56	72.71	101.9	71.96	112.5	70.74	125.4	69.94	136.5
250A	600	39.45	10.36	37.54	18.02	35.93	25.92	34.56	33.71	33.33	41.48	32.19	49.20	31.19	56.8	30.35	64.3	29.51	71.8	28.90	79.2
	750	50.92	12.95	49.00	22.52	47.40	32.40	46.02	42.14	44.80	51.85	43.65	61.50	42.66	71.0	41.82	80.4	40.98	89.7	40.37	99.0
	900	62.38	15.53	60.47	27.03	58.87	38.88	57.49	50.57	56.27	62.22	55.12	73.80	54.13	85.2	53.29	96.5	52.44	107.7	51.83	118.8
	1050	73.85	18.12	71.94	31.53	70.33	45.36	68.96	58.99	67.73	72.59	66.59	86.10	65.59	99.4	64.75	112.6	63.91	125.6	63.30	138.6
	1200	85.32	20.71	83.41	36.04	81.80	51.84	80.43	67.42	79.20	82.96	78.06	98.39	77.06	113.6	76.22	128.7	75.38	143.6	74.77	158.5
	1350	96.79	23.30	94.87	40.54	93.27	58.32	91.89	75.85	90.67	93.33	89.52	110.69	88.53	127.8	87.69	144.7	86.85	161.5	86.24	178.3
	1500	108.25	25.89	106.34	45.05	104.73	64.80	103.36	84.28	102.13	103.70	101.0	123.0	100.0	142.0	99.16	160.8	98.3	179.5	97.70	198.1
300	600	58.94	14.44	55.49	25.88	53.71	37.23	52.04	47.70	50.48	58.83	49.26	68.88	47.59	79.49	46.70	88.83	45.59	103.04	44.48	113.68
	750	75.62	18.06	72.17	32.35	70.39	46.54	68.72	59.63	67.16	73.53	65.94	86.10	64.27	99.36	63.38	111.0	62.27	128.80	61.16	142.1
	900	92.30	21.67	88.85	38.82	87.07	55.85	85.40	71.55	83.84	88.24	82.62	103.3	80.95	119.2	80.06	133.3	78.95	154.6	77.84	170.5
	1050	109.0	25.28	105.5	45.29	103.7	65.16	102.1	83.48	100.5	102.9	99.30	120.5	97.63	139.1	96.74	155.5	95.63	180.3	94.52	198.9
	1200	125.7	28.89	122.2	51.76	120.4	74.46	118.8	95.41	117.2	117.7	116.0	137.8	114.3	159.0	113.4	177.7	112.3	206.1	111.2	227.4
	1350	142.3	32.50	138.9	58.23	137.1	83.77	135.4	107.3	133.9	132.4	132.7	155.0	131.0	178.8	130.1	199.9	129.0	231.8	127.9	255.8
	1500	159.0	36.11	155.6	64.70	153.8	93.08	152.1	119.3	150.6	147.1	149.3	172.2	147.7	198.7	146.8	222.1	145.7	257.6	144.6	284.2
300A	600	88.3	21.07	85.0	37.30	82.3	53.64	80.0	71.4	78.1	87.0	76.1	103.1	74.5	119.0	72.5	136.5	70.5	152.3	69.0	168.0
	700	104.7	24.58	101.4	43.52	98.7	62.58	96.4	83.3	94.5	101.5	92.5	120.3	90.9	138.9	88.9	159.3	86.9	177.6	85.4	196.0
	800	121.1	28.10	117.8	49.74	115.1	71.52	112.8	95.2	110.9	116.0	108.9	137.5	107.3	158.7	105.3	182.1	103.3	203.0	101.8	224.0
	900	137.5	31.61	134.2	55.95	131.5	80.46	129.2	107.1	127.3	130.5	125.3	154.7	123.7	178.6	121.7	204.8	119.7	228.4	118.2	252.0
	1000	153.9	35.12	150.6	62.17	147.9	89.39	145.6	119.0	143.7	145.0	141.7	171.9	140.1	198.4	138.1	227.6	136.1	253.8	134.6	280.0
	1100	170.3	38.63	167.0	68.39	164.3	98.33	162.0	130.9	160.1	159.5	158.1	189.1	156.5	218.2	154.5	250.3	152.5	279.2	151.0	308.0
	1200	186.7	42.15	183.4	74.60	180.7	107.27	178.4	142.8	176.5	174.0	174.5	206.3	172.9	238.1	170.9	273.1	168.9	304.5	167.4	336.0
350	600	138.3	32.31	133.1	58.00	129.0	83.48	125.2	109.6	121.9	134.1	119.1	160.3	116.3	182.7	113.5	212.3	110.7	236.3	107.9	260.7
	700	163.8	37.70	158.6	67.67	154.5	97.39	150.7	127.9	147.4	156.4	144.6	187.1	141.8	213.2	139.0	247.7	136.2	275.7	133.4	304.1
	800	189.3	43.08	184.1	77.33	180.0	111.3	176.2	146.2	172.9	178.8	170.1	213.8	167.3	243.7	164.5	283.1	161.7	315.1	158.9	347.6
	900	214.8	48.47	209.6	87.00	205.5	125.2	201.7	164.5	198.4	201.1	195.6	240.5	192.8	274.1	190.0	318.5	187.2	354.4	184.4	391.0
	1000	240.3	53.85	235.1	96.67	231.0	139.1	227.2	182.7	223.9	223.4	221.1	267.2	218.3	304.6	215.5	353.9	212.7	393.8	209.9	434.5
	1100	265.8	59.24	260.6	106.3	256.5	153.0	252.7	201.0	249.4	245.8	246.6	294.0	243.8	335.0	241.0	389.2	238.2	433.2	235.4	477.9
	1200	291.3	64.62	286.1	116.0	282.0	167.0	278.2	219.3	274.9	268.1	272.1	320.7	269.3	365.5	266.5	424.6	263.7	472.6	260.9	521.4
400	600	236.3	53.28	230.3	95.65	225.5	137.7	221.3	180.8	217.6	221.1	214.1	264.4	211.3	301.4	208.8	350.1	206.1	389.7	203.1	429.9
	650	257.4	57.73	251.4	103.6	246.5	149.1	242.3	195.9	238.6	239.5	235.2	286.5	232.3	326.5	229.8	379.3	227.1	422.1	224.1	465.7
	700	278.4	62.17	272.4	111.6	267.5	160.6	263.3	210.9	259.6	257.9	256.2	308.5	253.4	351.6	250.8	408.5	248.1	454.6	245.2	501.6
	750	299.4	66.61	293.4	119.6	288.6	172.1	284.4	226.0	280.7	276.4	277.2	330.5	274.4	376.7	271.9	437.7	269.1	487.1	266.2	537.4
	800	320.4	71.05	314.4	127.5	309.6	183.6	305.4	241.1	301.7	294.8	298.2	352.6	295.4	401.8	292.9	466.8	290.2	519.6	287.2	573.2
	850	341.5	75.49																		

Roots Vacuum Type of LTV/RTSV Performance Table

TYPE	RPM	VCACUUM(mmAq)															
		-1000		-2000		-2500		-3000		-3500		-4000		-4500		-5000	
		m ³ /min	kW	m ³ /min	kW	m ³ /min	kW	m ³ /min	kW	m ³ /min	kW	m ³ /min	kW	m ³ /min	kW	m ³ /min	kW
040	1650	0.60	0.19	0.58	0.37	0.55	0.44	0.51	0.50	0.50	0.56	0.48	0.62	0.46	0.68	0.44	0.73
	1800	0.68	0.21	0.65	0.40	0.62	0.48	0.59	0.55	0.58	0.61	0.55	0.67	0.54	0.74	0.52	0.80
	1950	0.75	0.23	0.72	0.43	0.70	0.51	0.66	0.59	0.65	0.67	0.62	0.73	0.62	0.80	0.60	0.86
	2100	0.83	0.24	0.80	0.47	0.77	0.55	0.74	0.64	0.72	0.72	0.70	0.79	0.70	0.86	0.68	0.93
	2250	0.90	0.26	0.87	0.50	0.85	0.59	0.81	0.69	0.80	0.77	0.77	0.84	0.78	0.92	0.76	0.99
	2400	0.97	0.28	0.95	0.53	0.92	0.63	0.88	0.73	0.87	0.82	0.85	0.90	0.86	0.98	0.84	1.06
	2550	1.05	0.30	1.02	0.57	0.99	0.67	0.96	0.78	0.95	0.87	0.92	0.95	0.94	1.04	0.92	1.13
050	850	0.99	0.41	0.82	0.80	0.72	0.98	0.61	1.16	0.51	1.34	0.36	1.51	0.27	1.67	0.14	1.84
	1000	1.31	0.48	1.14	0.94	1.04	1.16	0.93	1.37	0.83	1.57	0.69	1.77	0.59	1.97	0.46	2.16
	1150	1.63	0.56	1.47	1.08	1.36	1.33	1.25	1.57	1.15	1.81	1.01	2.04	0.91	2.27	0.79	2.49
	1300	1.95	0.63	1.79	1.22	1.69	1.50	1.58	1.78	1.48	2.05	1.33	2.31	1.24	2.56	1.11	2.81
	1450	2.27	0.70	2.11	1.36	2.01	1.68	1.90	1.98	1.80	2.28	1.65	2.57	1.56	2.86	1.43	3.13
	1600	2.60	0.77	2.43	1.50	2.33	1.85	2.22	2.19	2.12	2.52	1.97	2.84	1.88	3.15	1.75	3.46
	1750	2.92	0.85	2.75	1.64	2.65	2.02	2.54	2.39	2.44	2.75	2.29	3.11	2.20	3.45	2.07	3.78
065	850	2.09	0.66	1.91	1.28	1.80	1.58	1.68	1.87	1.55	2.15	1.41	2.42	1.26	2.69	1.09	2.95
	1000	2.60	0.78	2.43	1.51	2.32	1.86	2.19	2.20	2.07	2.53	1.92	2.85	1.77	3.16	1.60	3.47
	1150	3.12	0.89	2.95	1.73	2.84	2.14	2.71	2.53	2.58	2.91	2.44	3.28	2.29	3.64	2.12	3.99
	1300	3.64	1.01	3.46	1.96	3.35	2.41	3.23	2.86	3.10	3.29	2.96	3.71	2.81	4.11	2.64	4.51
	1450	4.15	1.13	3.98	2.19	3.87	2.69	3.74	3.19	3.62	3.67	3.47	4.13	3.32	4.59	3.15	5.03
	1600	4.67	1.24	4.50	2.41	4.39	2.97	4.26	3.52	4.13	4.05	3.99	4.56	3.84	5.06	3.67	5.55
	1750	5.19	1.36	5.01	2.64	4.90	3.25	4.78	3.85	4.65	4.42	4.51	4.99	4.36	5.54	4.19	6.08
080	850	3.24	1.12	2.83	2.14	2.60	2.62	2.36	3.08	2.10	3.52	1.83	3.94	1.54	4.34	1.23	4.73
	1000	4.14	1.32	3.73	2.52	3.50	3.08	3.26	3.62	3.00	4.14	2.73	4.63	2.44	5.11	2.13	5.57
	1150	5.04	1.51	4.63	2.90	4.40	3.54	4.16	4.16	3.90	4.76	3.63	5.33	3.34	5.88	3.03	6.40
	1300	5.94	1.71	5.53	3.27	5.30	4.01	5.06	4.71	4.80	5.38	4.53	6.02	4.24	6.64	3.93	7.24
	1450	6.84	1.91	6.43	3.65	6.20	4.47	5.96	5.25	5.70	6.00	5.43	6.72	5.14	7.41	4.83	8.08
	1600	7.74	2.11	7.33	4.03	7.10	4.93	6.86	5.79	6.60	6.62	6.33	7.41	6.04	8.18	5.73	8.91
	1750	8.64	2.30	8.23	4.41	8.00	5.39	7.76	6.33	7.50	7.24	7.23	8.11	6.94	8.94	6.63	9.75
100	850	5.79	1.57	5.19	3.00	4.85	3.67	4.48	4.31	4.09	4.92	3.67	5.51	3.22	6.08	2.74	6.63
	1000	7.05	1.84	6.45	3.53	6.11	4.31	5.74	5.07	5.35	5.79	4.93	6.49	4.48	7.15	4.00	7.80
	1150	8.31	2.12	7.71	4.05	7.37	4.96	7.00	5.83	6.61	6.66	6.19	7.46	5.74	8.23	5.26	8.97
	1300	9.57	2.40	8.97	4.58	8.63	5.61	8.26	6.59	7.87	7.53	7.45	8.43	7.00	9.30	6.52	10.14
	1450	10.83	2.67	10.23	5.11	9.89	6.25	9.52	7.35	9.13	8.40	8.71	9.41	8.26	10.37	7.78	11.31
	1600	12.09	2.95	11.49	5.64	11.15	6.90	10.78	8.11	10.39	9.27	9.97	10.38	9.52	11.45	9.04	12.47
	1750	13.35	3.23	12.75	6.17	12.41	7.55	12.04	8.87	11.65	10.14	11.23	11.35	10.78	12.52	10.30	13.64
125S	750	8.13	2.05	7.35	3.91	6.93	4.79	6.48	5.63	6.01	6.43	5.53	7.20	5.00	7.94	4.46	8.66
	900	10.02	2.46	9.24	4.70	8.82	5.75	8.37	6.75	7.90	7.72	7.42	8.64	6.89	9.53	6.35	10.39
	1050	11.91	2.86	11.13	5.48	10.71	6.70	10.26	7.88	9.79	9.00	9.31	10.08	8.78	11.12	8.24	12.12
	1200	13.80	3.27	13.02	6.26	12.60	7.66	12.15	9.00	11.68	10.29	11.20	11.52	10.67	12.71	10.13	13.85
	1350	15.69	3.68	14.91	7.04	14.49	8.62	14.04	10.13	13.57	11.57	13.09	12.96	12.56	14.30	12.02	15.59
	1500	17.58	4.09	16.80	7.83	16.38	9.58	15.93	11.25	15.46	12.86	14.98	14.40	14.45	15.89	13.91	17.32
	1650	19.47	4.50	18.69	8.61	18.27	10.53	17.82	12.38	17.35	14.14	16.87	15.84	16.34	17.48	15.80	19.05
125	750	10.29	2.59	9.30	4.96	8.78	6.06	8.20	7.13	7.61	8.14	7.01	9.12	6.34	10.06	5.65	10.97
	900	12.69	3.11	11.70	5.95	11.17	7.28	10.60	8.55	10.01	9.77	9.40	10.95	8.73	12.07	8.04	13.16
	1050	15.08	3.63	14.09	6.94	13.57	8.49	12.99	9.98	12.40	11.40	11.79	12.77	11.12	14.09	10.44	15.35
	1200	17.48	4.15	16.49	7.93	15.96	9.70	15.39	11.40	14.79	13.03	14.19	14.59	13.52	16.10	12.83	17.55
	1350	19.87	4.66	18.88	8.92	18.35	10.92	17.78	12.83	17.19	14.66	16.58	16.42	15.91	18.11	15.23	19.74
	1500	22.26	5.18	21.27	9.91	20.75	12.13	20.17	14.25	19.58	16.29	18.98	18.24	18.31	20.12	17.62	21.93
	1650	24.66	5.70	23.67	10.90	23.14	13.34	22.57	15.68	21.98	17.92	21.37	20.07	20.70	22.14	20.01	24.13
150	750	13.32	3.34	12.55	6.39	12.14	7.82	11.69	9.19	11.20	10.50	10.68	11.76	10.13	12.97	9.55	14.14
	900	16.40	4.01	15.64	7.67	15.23	9.38	14.78	11.03	14.28	12.60	13.77	14.11	13.21	15.57	12.64	16.97
	1050	19.49	4.68	18.73	8.95	18.32	10.95	17.86	12.86	17.37	14.70	16.86	16.47	16.30	18.16	15.72	19.80
	1200	22.58	5.35	21.81	10.23	21.40	12.51	20.95	14.70	20.46	16.80	19.94	18.82	19.39	20.76	18.81	22.62
	1350	25.66	6.02	24.90	11.50	24.49	14.07	24.04	16.54	23.54	18.90	23.03	21.17	22.47	23.35	21.90	25.45
	1500	28.75	6.68	27.99	12.78	27.58	15.64	27.12	18.38	26.63	21.00	26.12	23.52	25.56	25.95	24.98	28.28
	1650	31.84	7.35	31.08	14.06	30.66	17.20	30.21	20.21	29.72	23.10	29.20	25.88	28.65	28.54	28.07	31.11

9 Performance Table

Roots Pressure Type of LTV/RTSV Performance Table

TYPE	RPM	VCACUUM(mmAq)															
		-1000		-2000		-2500		-3000		-3500		-4000		-4500		-5000	
		m ³ /min	kW	m ³ /min	kW	m ³ /min	kW	m ³ /min	kW	m ³ /min	kW	m ³ /min	kW	m ³ /min	kW	m ³ /min	kW
200	600	17.01	4.84	15.99	9.27	15.42	11.34	14.86	13.32	14.21	15.23	13.49	17.06	12.78	18.82	11.98	20.51
	750	22.68	6.05	21.66	11.58	21.09	14.17	20.53	16.65	19.88	19.04	19.16	21.32	18.45	23.52	17.65	25.64
	900	28.35	7.27	27.33	13.90	26.76	17.01	26.20	19.98	25.55	22.84	24.83	25.59	24.12	28.23	23.32	30.77
	1050	34.02	8.48	33.00	16.22	32.43	19.84	31.87	23.32	31.22	26.65	30.50	29.85	29.79	32.93	28.99	35.89
	1200	39.69	9.69	38.67	18.53	38.10	22.67	37.54	26.65	36.89	30.46	36.17	34.12	35.46	37.64	34.66	41.02
	1350	45.36	10.90	44.34	20.85	43.77	25.51	43.21	29.98	42.56	34.26	41.84	38.38	41.13	42.34	40.33	46.15
	1500	51.03	12.11	50.01	23.17	49.44	28.34	48.88	33.31	48.23	38.07	47.51	42.65	46.80	47.05	46.00	51.28
200A	600	27.72	7.40	26.22	14.16	25.35	17.32	24.43	20.35	23.45	23.27	22.35	26.06	21.19	28.75	19.98	31.34
	750	36.38	9.25	34.88	17.70	34.01	21.65	33.09	25.44	32.11	29.08	31.01	32.58	29.86	35.94	28.64	39.17
	900	45.05	11.10	43.54	21.24	42.68	25.98	41.75	30.53	40.77	34.90	39.67	39.09	38.52	43.13	37.31	47.01
	1050	53.71	12.95	52.21	24.77	51.34	30.31	50.42	35.62	49.43	40.72	48.34	45.61	47.18	50.31	45.97	54.84
	1200	62.37	14.80	60.87	28.31	60.00	34.64	59.08	40.71	58.10	46.53	57.00	52.12	55.84	57.50	54.63	62.67
	1350	71.03	16.65	69.53	31.85	68.66	38.97	67.74	45.80	66.76	52.35	65.66	58.64	64.51	64.69	63.29	70.51
	1500	79.7	18.50	78.2	35.39	77.3	43.30	76.4	50.89	75.4	58.16	74.3	65.16	73.17	71.88	71.96	78.34
250	600	27.72	7.40	26.22	14.16	25.35	17.32	24.43	20.35	23.45	23.27	22.35	26.06	21.19	28.75	19.98	31.34
	750	36.38	9.25	34.88	17.70	34.01	21.65	33.09	25.44	32.11	29.08	31.01	32.58	29.86	35.94	28.64	39.17
	900	45.05	11.10	43.54	21.24	42.68	25.98	41.75	30.53	40.77	34.90	39.67	39.09	38.52	43.13	37.31	47.01
	1050	53.71	12.95	52.21	24.77	51.34	30.31	50.42	35.62	49.43	40.72	48.34	45.61	47.18	50.31	45.97	54.84
	1200	62.37	14.80	60.87	28.31	60.00	34.64	59.08	40.71	58.10	46.53	57.00	52.12	55.84	57.50	54.63	62.67
	1350	71.03	16.65	69.53	31.85	68.66	38.97	67.74	45.80	66.76	52.35	65.66	58.64	64.51	64.69	63.29	70.51
	1500	79.7	18.50	78.19	35.39	77.33	43.30	76.40	50.89	75.42	58.16	74.32	65.16	73.17	71.88	71.96	78.34
250A	600	39.31	10.34	37.13	17.81	35.63	21.47	34.37	25.13	33.01	28.89	31.74	32.48	30.37	35.83	28.82	39.97
	750	50.78	12.92	48.60	22.26	47.09	26.84	45.84	31.41	44.48	36.12	43.21	40.59	41.83	44.78	40.29	49.97
	900	62.25	15.50	60.07	26.72	58.56	32.21	57.31	37.70	55.95	43.34	54.68	48.71	53.30	53.74	51.76	59.96
	1050	73.71	18.09	71.53	31.17	70.03	37.57	68.77	43.98	67.41	50.57	66.14	56.83	64.77	62.70	63.22	69.95
	1200	85.18	20.67	83.00	35.62	81.50	42.94	80.24	50.26	78.88	57.79	77.61	64.95	76.24	71.65	74.69	79.95
	1350	96.65	23.26	94.47	40.07	92.96	48.31	91.71	56.55	90.35	65.01	89.08	73.07	87.70	80.61	86.16	89.94
	1500	108.1	25.84	105.9	44.53	104.4	53.68	103.2	62.83	101.8	72.24	100.5	81.19	99.17	89.57	97.63	99.93
300	600	58.94	14.25	56.27	27.26	54.82	33.35	53.15	39.19	51.49	44.80	49.71	50.18	47.70	55.36	45.70	60.34
	750	75.62	17.81	72.95	34.07	71.50	41.69	69.83	48.99	68.17	56.00	66.39	62.72	64.38	69.20	62.38	75.42
	900	92.30	21.38	89.63	40.89	88.18	50.02	86.51	58.79	84.85	67.20	83.07	75.27	81.06	83.04	79.06	90.51
	1050	109.0	24.94	106.3	47.70	104.9	58.36	103.2	68.58	101.5	78.40	99.75	87.81	97.74	96.88	95.74	105.6
	1200	125.7	28.50	123.0	54.52	121.5	66.70	119.9	78.38	118.2	89.60	116.4	100.4	114.4	110.7	112.4	120.7
	1350	142.3	32.06	139.7	61.33	138.2	75.04	136.6	88.18	134.9	100.8	133.1	112.9	131.1	124.6	129.1	135.8
	1500	159.0	35.63	156.3	68.15	154.9	83.37	153.2	97.98	151.6	112.0	149.8	125.4	147.8	138.4	145.8	150.8
300A	600	88.2	21.04	84.4	36.86	82.0	44.47	79.7	53.34	77.7	60.6	75.3	68.0	72.5	77.0	69.0	84.7
	700	104.6	24.54	100.9	43.01	98.4	51.88	96.2	62.23	94.1	70.6	91.8	79.4	89.0	89.8	85.5	98.9
	800	121.0	28.05	117.3	49.15	114.8	59.29	112.6	71.12	110.5	80.7	108.2	90.7	105.4	102.7	101.9	113.0
	900	137.5	31.56	133.7	55.29	131.3	66.70	129.1	80.00	127.0	90.8	124.7	102.0	121.8	115.5	118.4	127.1
	1000	153.9	35.06	150.2	61.44	147.7	74.11	145.5	88.89	143.4	100.9	141.1	113.4	138.3	128.3	134.8	141.2
	1100	170.3	38.57	166.6	67.58	164.1	81.52	161.9	97.78	159.9	111.0	157.5	124.7	154.7	141.2	151.2	155.3
	1200	186.8	42.07	183.0	73.72	180.6	88.93	178.4	106.7	176.3	121.1	174.0	136.1	171.1	154.0	167.7	169.5
350	600	138.1	32.72	132.3	57.32	128.5	69.15	124.7	82.94	121.4	94.16	117.9	105.8	113.5	119.8	107.9	131.7
	700	163.6	38.17	157.8	66.87	154.0	80.67	150.2	96.77	146.9	109.9	143.4	123.4	139.0	139.7	133.4	153.7
	800	189.1	43.63	183.3	76.42	179.5	92.20	175.7	110.6	172.4	125.6	168.9	141.1	164.5	159.7	158.9	175.7
	900	214.6	49.08	208.8	85.97	205.0	103.7	201.2	124.4	197.9	141.2	194.4	158.7	190.0	179.6	184.4	197.6
	1000	240.1	54.53	234.3	95.53	230.5	115.2	226.7	138.2	223.4	156.9	219.9	176.3	215.5	199.6	209.9	219.6
	1100	265.6	59.99	259.8	105.1	256.0	126.8	252.2	152.1	248.9	172.6	245.4	193.9	241.0	219.6	235.4	241.5
	1200	291.1	65.44	285.3	114.6	281.5	138.3	277.7	165.9	274.4	188.3	270.9	211.6	266.5	239.5	260.9	263.5
400	600	236.3	52.99	228.3	95.77	224.6	117.3	219.5	137.9	216.6	159.0	212.4	180.5	209.4	212.8	203.5	223.0
	650	257.4	57.40	249.4	103.8	245.6	127.1	240.5	149.4	237.6	172.3	233.4	195.5	230.5	230.5	224.6	241.6
	700	278.4	61.82	270.4	111.7	266.6	136.8	261.6	160.9	258.6	185.5	254.4	210.6	251.5	248.3	245.6	260.2
	750	299.4	66.23	291.4	119.7	287.6	146.6	282.6	172.4	279.7	198.8	275.4	225.6	272.5	266.0	266.6	278.8
	800	320.4	70.65	312.5	127.7	308.7	156.4	303.6	183.9	300.7	212.0	296.5	240.7	293.5	283.7	287.6	297.3
	850	341.5	75.07	333.5	135.7	329.7	166.2	324.6	195.4	321.7	225.3	317.5	255.7	314.6	301.5	308.7	315.9
	900	362.5	79.48	354.5	143.7	350.7	175.9	345.7	206.9	342.7	238.5	338.5	270.7	335.6	319.2	329.7	334.5

How to Use Performance Chart

- Air volume is general shown in terms of
 - Standard state(QS):
At 20°C, 10332 mmAq, And RH. 65%
 - Normal state(Qn):
At 0°C, 10332 mmAq, And RH. 0%
- Performance table shown the capacity at the standard suction state.
- Performance table shown the pressure at the static pressure.
- Volume conversion formula

$$Q_2 = Q_1 \cdot \frac{P_1}{P_2} \cdot \frac{T_2}{T_1}$$

- Q1(m³/min):Air volume in P1(mmAq),T1(°K)
- Q2(m³/min):Air volume in P2(mmAq),T2(°K)

5. Pressure conversion formula

(1) For Pressure

$$PS = \left(\frac{10332+P_1}{10332+P_2} - 1 \right) \cdot 10332$$

(2) For Vacuum

$$PS = \left(\frac{10332+P_1}{10332+P_2} - 1 \right) \cdot 10332$$

- P1:Suction Static Pressure
- P2:Discharge Static Pressure
- Ps:Static Pressure in Catalog

6. Example Operating Specifications:

- Air Volume 5.16m³/min
- Discharge Static Pressure +4260mmAq
- Suction Static Pressure -500mmAq
- Suction Temperature 40°C

CHOICE:

Air volume (5.16m³/min) converts to STP state

$$Q = 5.16 \cdot \frac{10332-500}{10332} \cdot \frac{273+20}{273+40} = 4.60\text{m}^3/\text{min}$$

Static pressure changed to:

$$PS = \left(\frac{10332+4260}{10332-500} - 1 \right) \cdot 10332 = 5000\text{mmAq}$$

You can find the LT-080 with 1300RPM and 10 HP can fits the specification at the performance or the performance table.

- As the selection covers two models, you can select the small models with for limited budget or the large models with lower noise and lower RPM.
Please refer them noise performance specification.

Performance Chart Conversion

◆ CAPACITY

	l m ³ /min	l m ³ /h	l/min	ft ³ /min
1 m ³ /min	1	60	1000	35.31
1 m ³ /h	0.017	1	16.67	0.589
1 l/min	0.001	0.06	1	0.035
1 ft ³ /min	0.028	1.699	28.32	1

◆ POWER

	kg-m/sec	kW	SP	PH
1 kg-m/sec	1	0.01	1000	0.013
1 kW	101.97	1	16.67	1.360
1 SP	76.038	0.06	0.746	1.014
1 PH	75	1.699	0.736	1

◆ PRESSURE

	mbar	Pa	atm	lbf/in ²	kgf/cm ²	in-Hg	mmAq
1 mbar	1	10 ²	9.869x10 ⁻⁴	1.45x10 ⁻²	1.02x10 ⁻³	2.953x10 ⁻²	10.197
1 Pa	0.01	1	9.869x10 ⁻⁶	1.45x10 ⁻⁴	1.02x10 ⁻⁵	2.953x10 ⁻⁴	0.102
1 atm	1.013x10 ³	1.013x10 ⁵	1	14.7	1.033	29.92	1.033x10 ⁴
1 lbf/in ²	68.95	6.895x10 ²	6.805x10 ⁻²	1	7.03x10 ⁻²	2.036	7.03x10 ²
1 kgf/cm ²	9.807x10 ²	9.807x10 ⁴	0.968	14.22	1	28.96	104
1 in-Hg	33.86	3.386x10 ³	3.342x10 ⁻²	0.491	3.45x10 ⁻²	1	3.45x10 ³
1 mmAq	9.807x10 ⁻²	9.807	9.677x10 ⁻⁵	1.42x10 ⁻³	10 ⁻⁴	2.896x10 ⁻³	1

LT/LTV Noise Level

LT/LTV-040

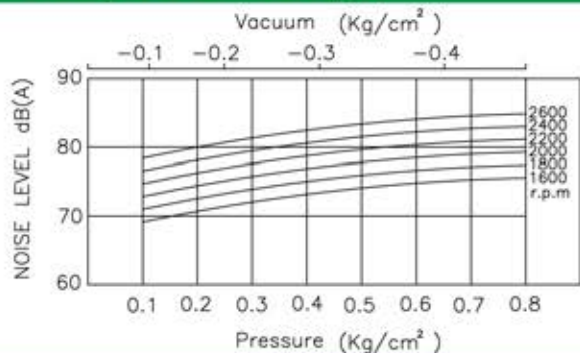

LT/LTV-100

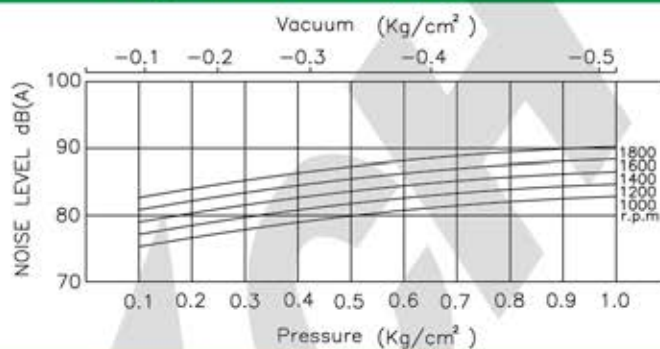

LT/LTV-050

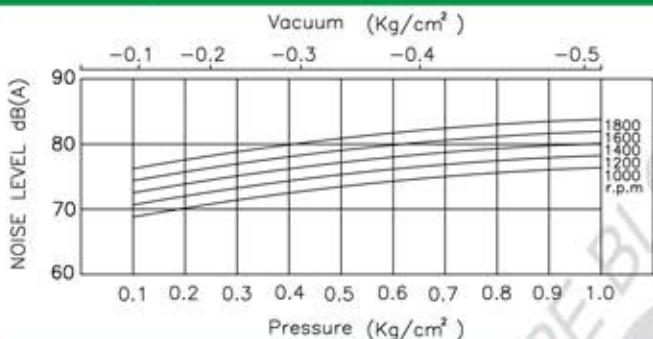

LT/LTV-125S

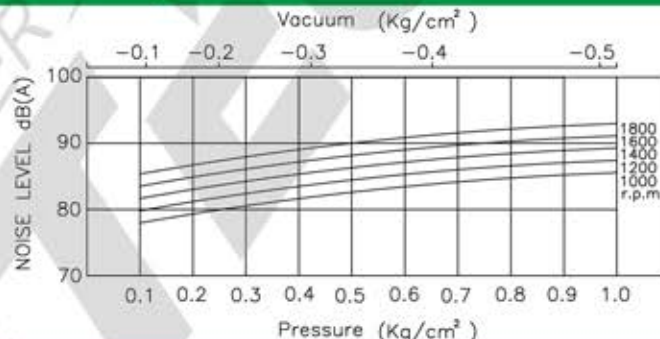

LT/LTV-065

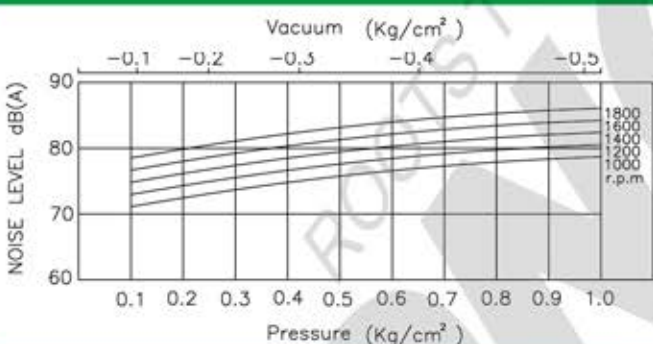

LT/LTV-125

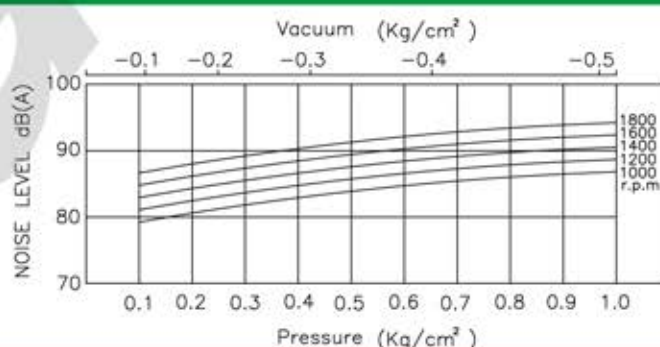

LT/LTV-080

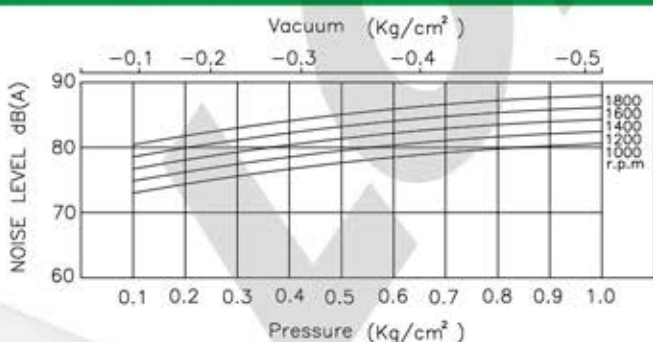

LT/LTV-150

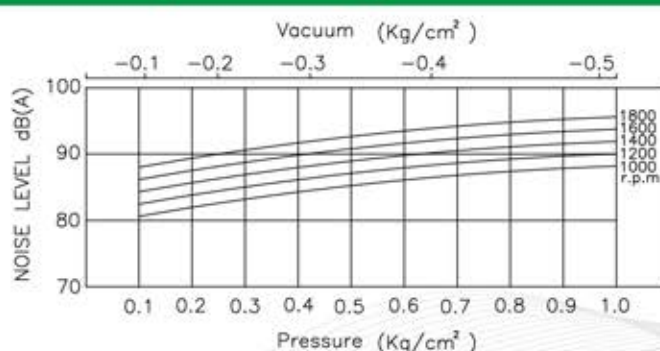

- * Noise Level measured at distance 1 meter for the blower fitted with standard silenced
- * Noise Level maybe different according to the extend pipe length and ambient condition

LT/LTV Noise Level

LT/LTV-200

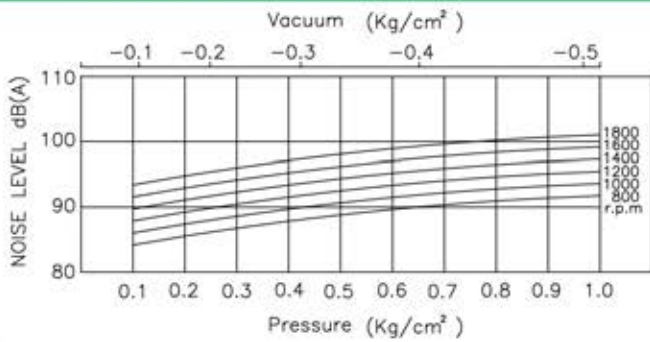

LT/LTV-300

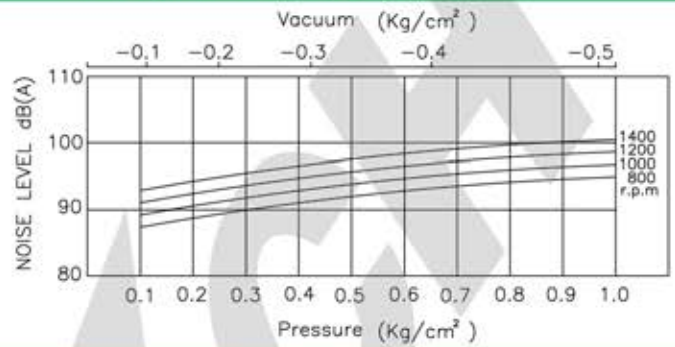

LT/LTV-200A

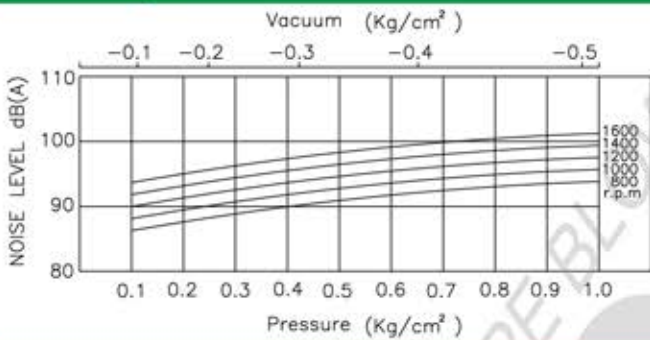

LT/LTV-300A

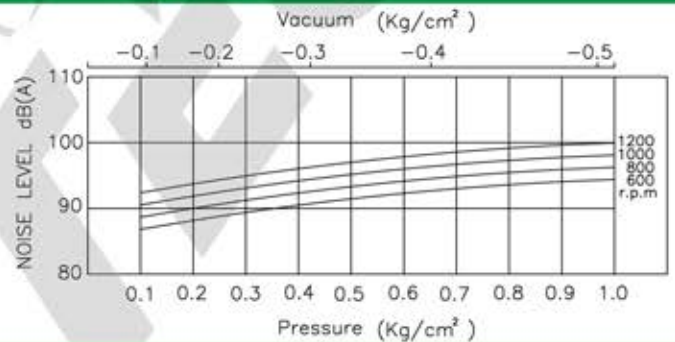

LT/LTV-250

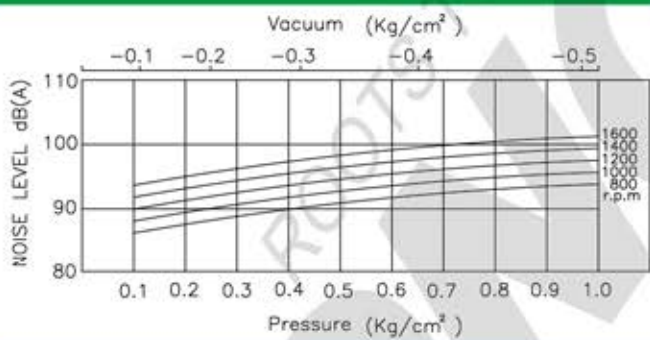

LT/LTV-350

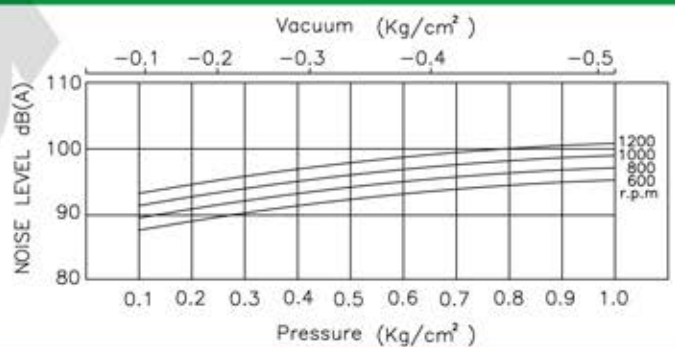

LT/LTV-250A

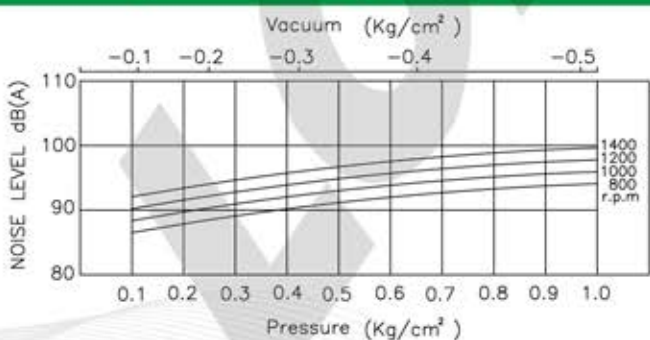

LT/LTV-400

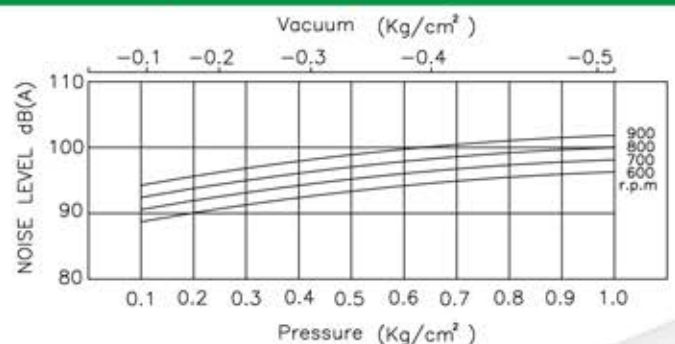

* Noise Level measured at distance 1 meter for the blower fitted with standard silenced
 * Noise Level maybe different according to the extend pipe length and ambient condition

RTS/RTSV Noise Level

RTS/RTSV-050

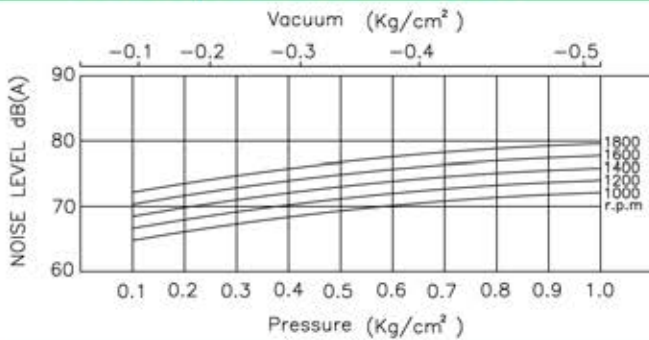

RTS/RTSV-125

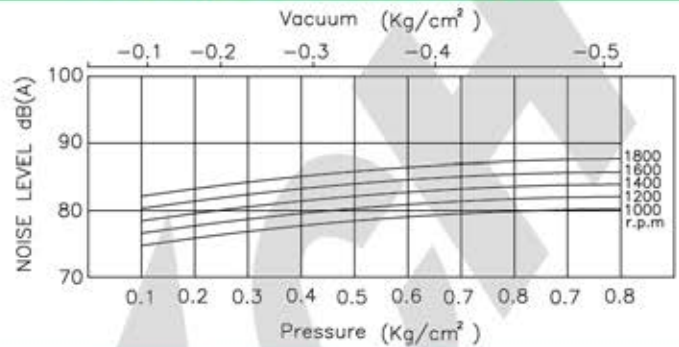

RTS/RTSV-065

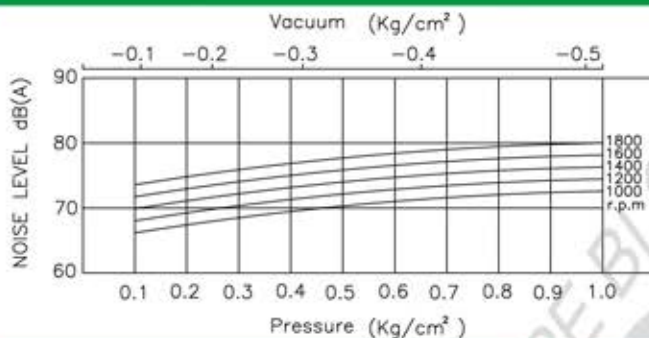

RTS/RTSV-150

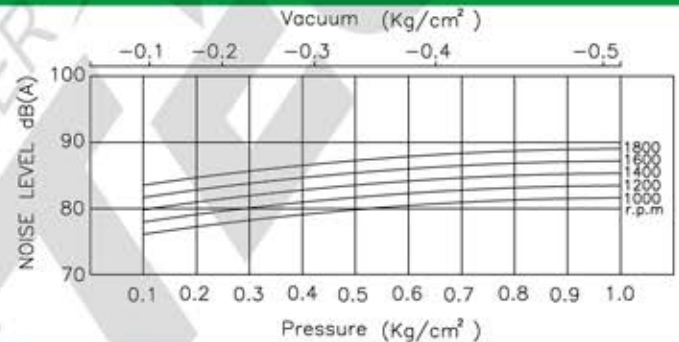

RTS/RTSV-080

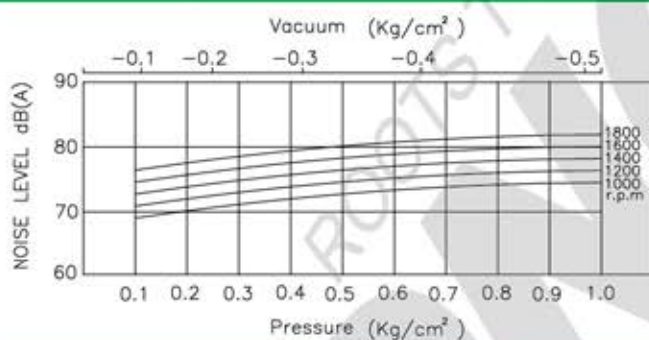

RTS/RTSV-200

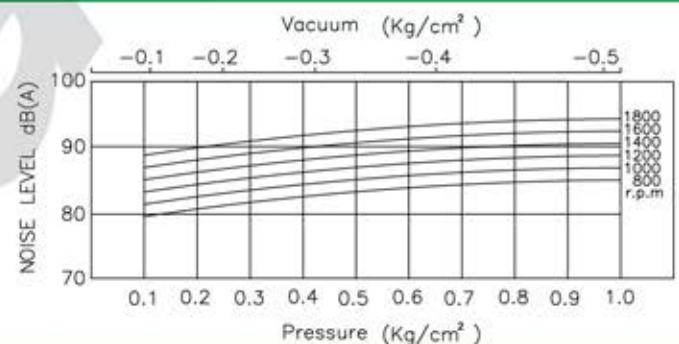

RTS/RTSV-100

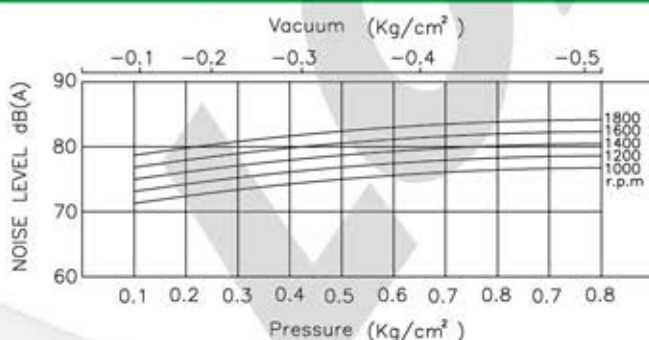

RTS/RTSV-250

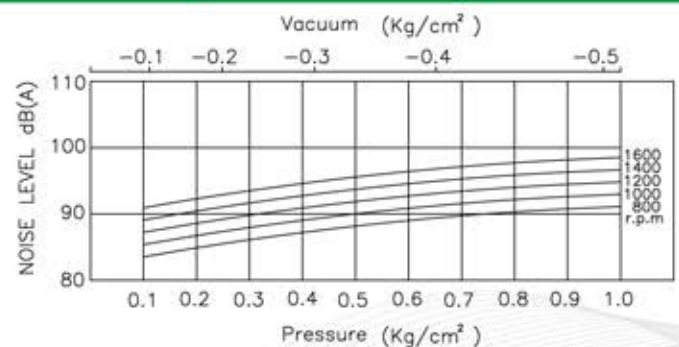

* Noise Level measured at distance 1 meter for the blower fitted with standard silenced
 * Noise Level maybe different according to the extend pipe length and ambient condition

Dimensions and Weights

040

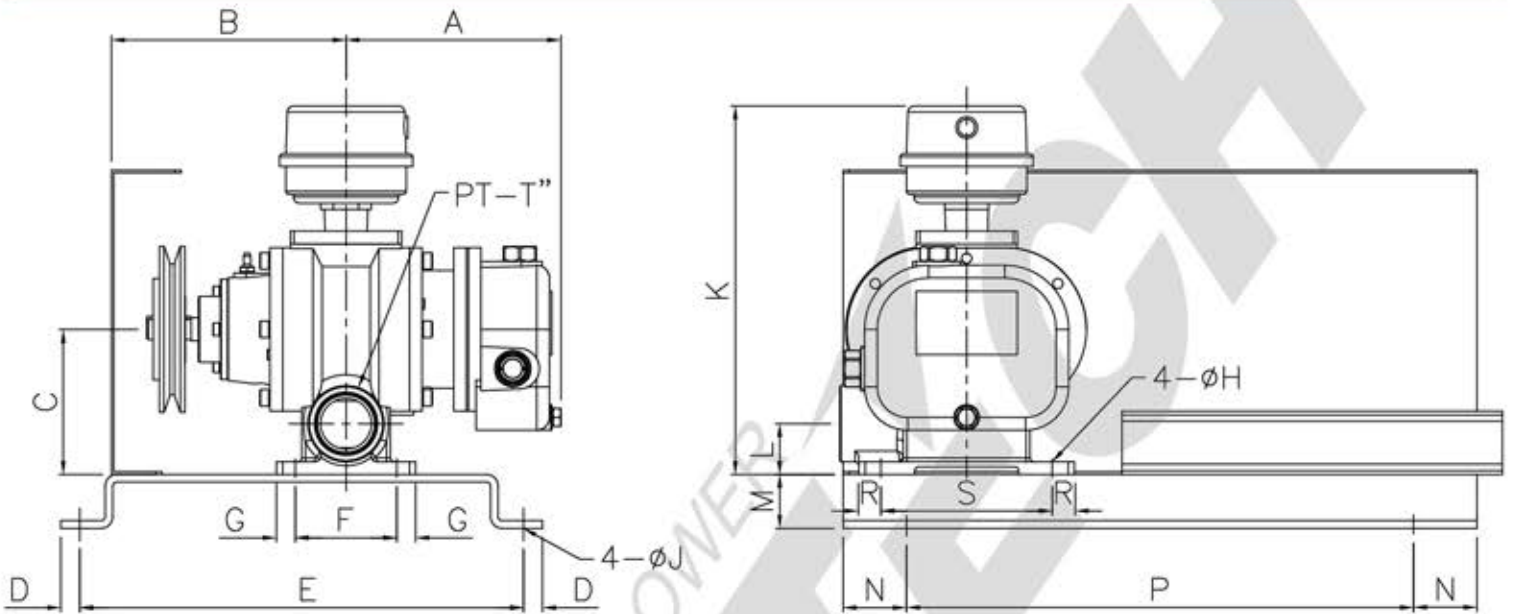

Wt.(Kgs):Main Body Weight
Unit:mm

MODEL	A	B	C	D	E	F	G	H	J	K	L	M	N	P	R	S	T	Wt.(Kgs)
LT-040	169	185	115	15	350	80	15	12	12	333	40	43	50	400	17.5	135	1.5	25

050~065

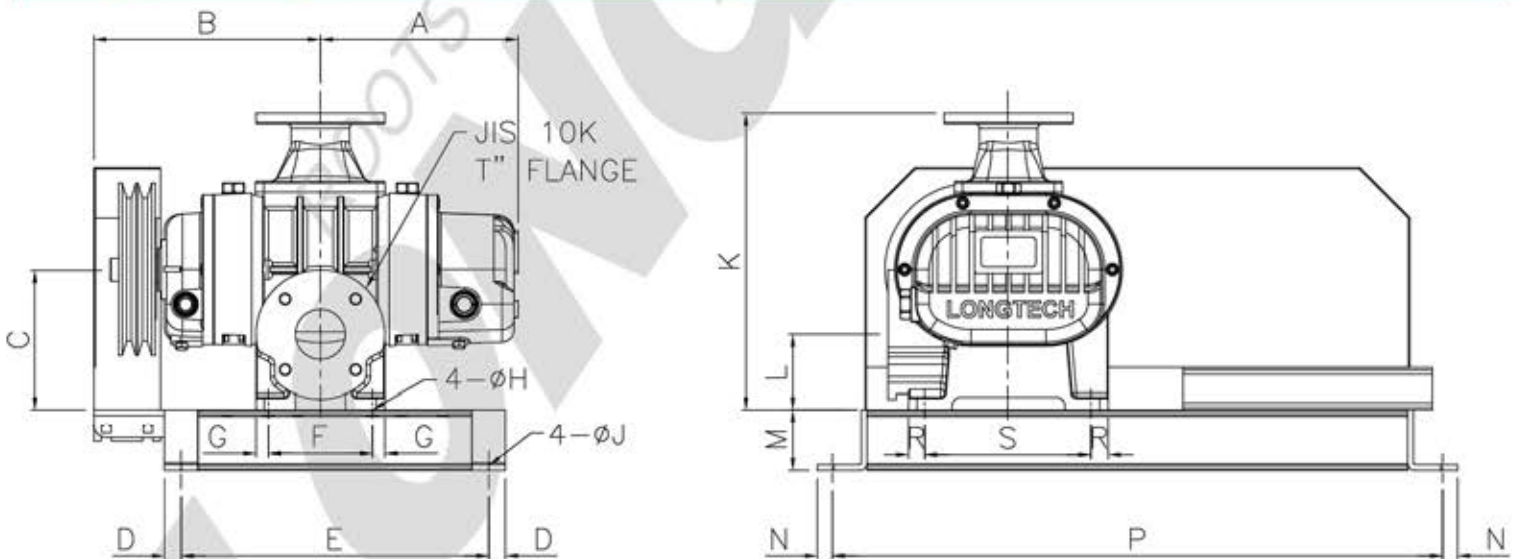

Wt.(Kgs):Main Body Weight
Unit:mm

MODEL	A	B	C	D	E	F	G	H	J	K	L	M	N	P	R	S	T	Wt.(Kgs)
050	238	273	168	20	370	125	15	15	15	356	90	75	18	734	15	200	2	76
065	281	315	173	20	370	210	15	15	15	360	95	75	18	734	15	200	2.5	94



Dimensions and Weights

080~150

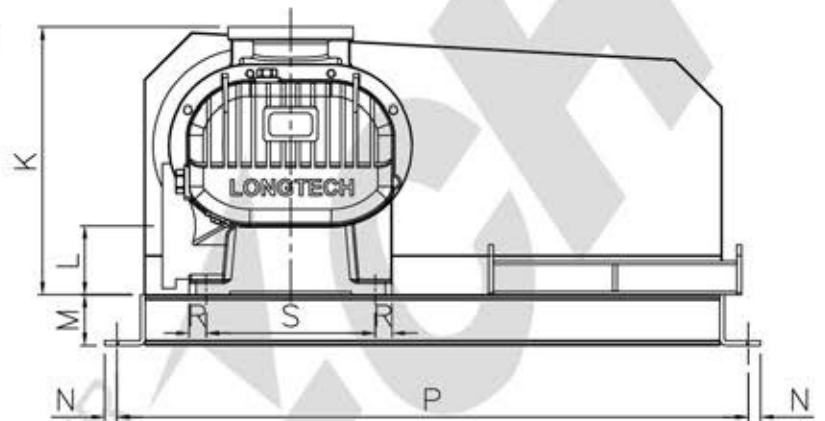
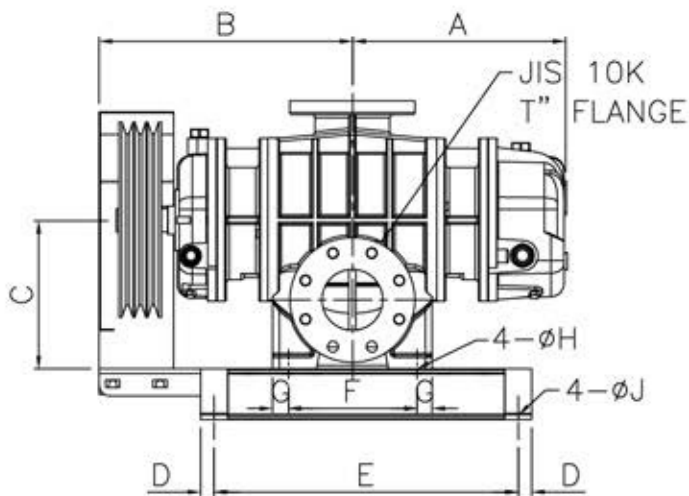

Wt.(Kgs):Main Body Weight
Unit:mm

MODEL	A	B	C	D	E	F	G	H	J	K	L	M	N	P	R	S	T	Wt.(Kgs)
LT-080	318	375	220	20	450	190	23	19	15	395	102	75	18	934	25	250	3	167
LT-100	368	425	220	20	450	290	20	19	15	395	115	75	18	934	25	250	4	193
LT-125S	406	445	265	25	605	230	26	19	19	475	145	100	20	1190	25	350	5	319
LT-125	446	490	305	25	605	320	21	19	19	520	155	100	20	1190	25	350	5	353
LT-150	501	543	305	25	605	425	24	19	19	520	155	100	20	1190	25	350	6	418

200~300

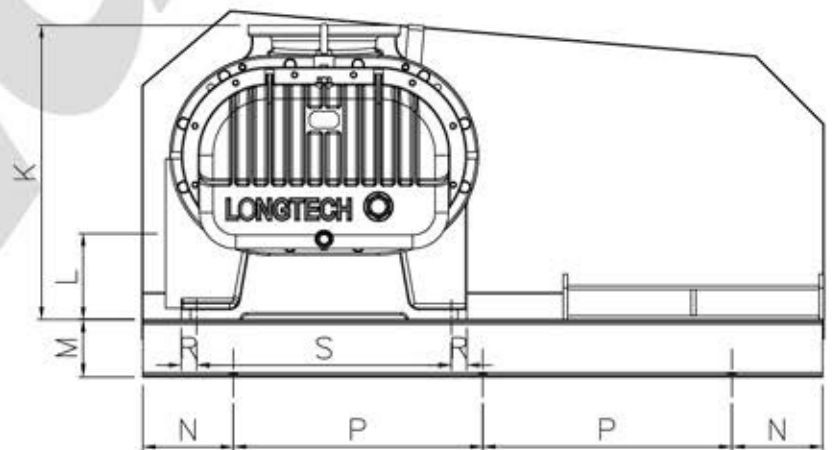
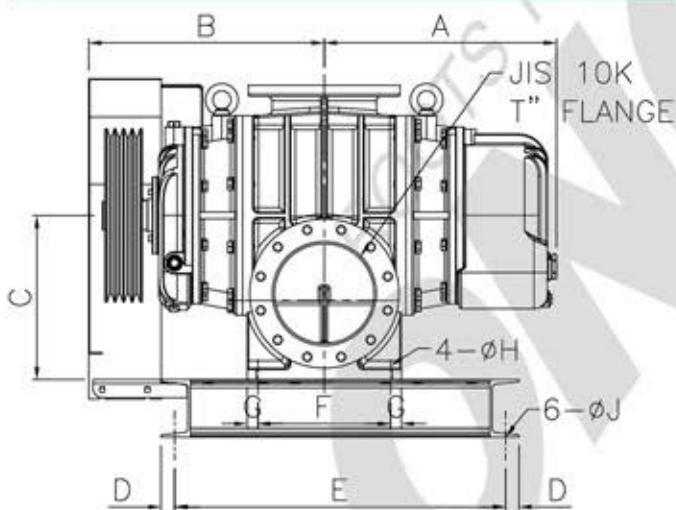

Wt.(Kgs):Main Body Weight
Unit:mm

MODEL	A	B	C	D	E	F	G	H	J	K	L	M	N	P	R	S	T	Wt.(Kgs)
LT-200	513	520	362	30	730	270	35	23	19	650	190	125	200	550	40	550	8	720
LT-200A	608	615	363	30	730	460	35	23	19	665	190	125	200	550	40	550	8	897
LT-250	608	595	388	30	730	460	35	23	19	675	225	125	200	550	40	550	10	913
LT-250A	692	768	500	40	1120	400	65	27	24	875	250	200	200	800	55	620	10	1665
LT-300	817	893	500	40	1120	650	65	27	24	875	250	200	200	800	55	620	12	2010

Dimensions and Weights

350

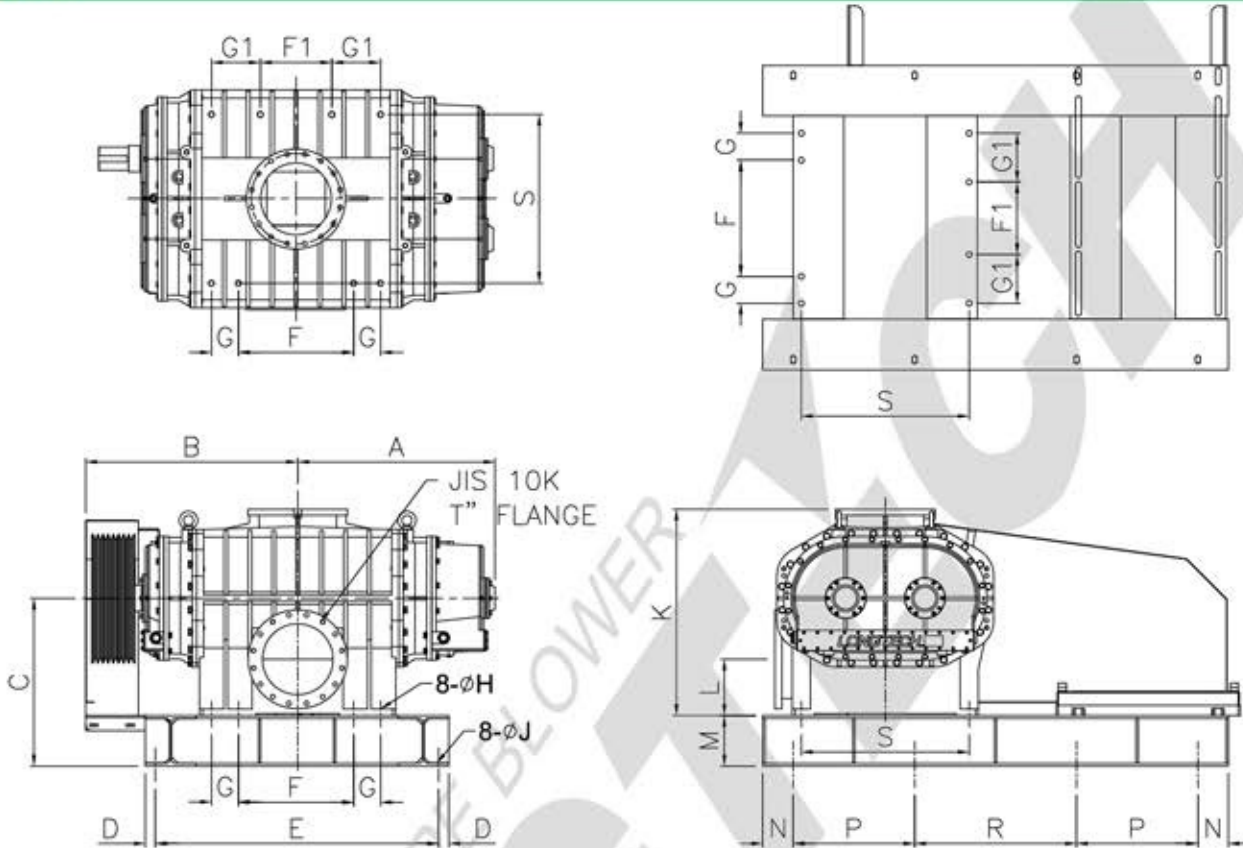

Wt.(Kgs):Main Body Weight
Units:mm

MODEL	A	B	C	D	E	F	F1	G	G1	H	J	K	L	M	N	P	R	S	T	Wt.(Kgs)
LT-350	975	1048	580	50	1400	570	354	133	241	28	24	1020	278	250	150	600	800	830	14	4100

400

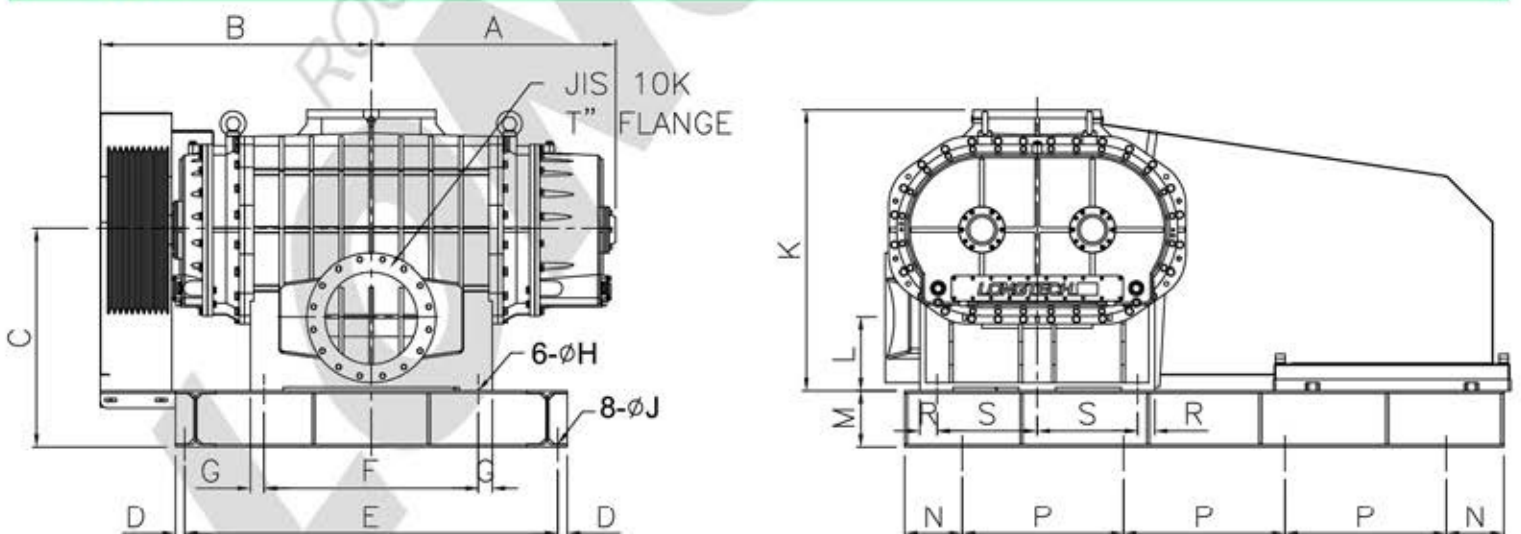

Wt.(Kgs):Main Body Weight
Units:mm

MODEL	A	B	C	D	E	F	G	H	J	K	L	M	N	P	R	S	T	Wt.(Kgs)
400	1061	1176	939	40	1620	930	60	35	24	1215	315	250	300	600	800	435	16	4650

Accessories

SUCTION SILENCER(OUTDOOR)

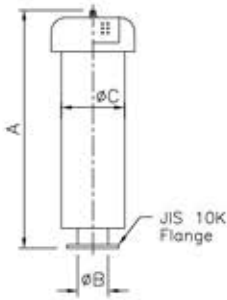

UNITS : mm

MODEL	A	B	C	COMPLIANCE
O-050	682	50	165	LT-050
O-065	682	65	165	LT-065
O-080	782	80	216	LT-080
O-100	782	100	216	LT-100
O-125	1303	125	349	LT-125
O-150	1303	150	349	LT-150
O-200	2018	200	525	LT-200
O-250	2023	250	600	LT-250
O-300	2226	300	700	LT-300
O-350	2536	350	797	LT-350
O-400	2538	400	797	LT-400

SUCTION SILENCER(INDOOR)

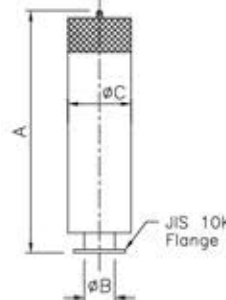

UNITS : mm

MODEL	A	B	C	COMPLIANCE
I-050	680	50	165	LT-050
I-065	680	65	165	LT-065
I-080	784	80	216	LT-080
I-100	834	100	216	LT-100
I-125	1300	125	349	LT-125
I-150	1300	150	349	LT-150
I-200	2030	200	525	LT-200
I-250	2030	250	600	LT-250
I-300	2230	300	700	LT-300
I-350	2570	350	800	LT-350
I-400	2570	400	800	LT-400

DISCHARGE SILENCER

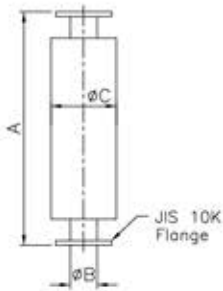

UNITS : mm

MODEL	A	B	C	COMPLIANCE
O-050	657	50	165	LT-050
O-065	657	65	165	LT-065
O-080	757	80	216	LT-080
O-100	760	100	216	LT-100
O-125	1188	125	349	LT-125
O-150	1188	150	349	LT-150
O-200	1726	200	525	LT-200
O-250	1730	250	600	LT-250
O-300	1750	300	703	LT-300
O-350	2224	350	797	LT-350
O-400	2228	400	797	LT-400

HORIZONTAL SILENCER

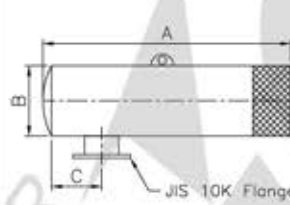

UNITS : mm

MODEL	A	B	C	COMPLIANCE
RO-050	586	165	120	LT-050
RO-065	586	165	120	LT-065
RO-080	721	216	150	LT-080
RO-100	721	216	150	LT-100
RO-125	1228	351	250	LT-125
RO-150	1228	351	250	LT-150
RO-200	1866	528	400	LT-200
RO-250	1866	602	400	LT-250
RO-300	2076	706	400	LT-300
RO-350	2373	800	400	LT-350
RO-400	2371	800	400	LT-400

"T" JOINT

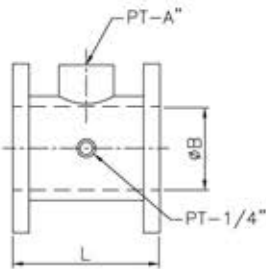

UNITS : mm

MODEL	A	B	L	COMPLIANCE
T-050	1.5"	50	150	LT-050
T-065	1.5"	65	150	LT-065
T-080	1.5"	80	165	LT-080
T-100	1.5"	100	165	LT-100
T-125	2"	125	205	LT-125
T-150	2"	150	210	LT-150
T-200	2"	200	265	LT-200

"T" JOINT

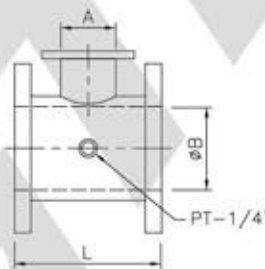

UNITS : mm

MODEL	A	B	L	COMPLIANCE
T-250	80	250	295	LT-250
T-300	80	300	350	LT-300
T-350	125	350	400	LT-350
T-400	125	400	500	LT-400

RELIEF VALVE

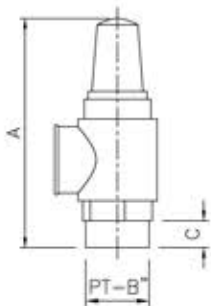

UNITS : mm

MODEL	A	B	C	COMPLIANCE
R-038	176	1.5"	19	LT-050-100
R-050	232	2"	26	LT-125-200

RELIEF VALVE

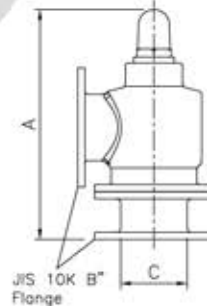

UNITS : mm

MODEL	A	B	C	COMPLIANCE
R-038	500	3"	80	LT-250-300
R-050	670	5"	125	LT-350-400

FLEXIBLE JOINT

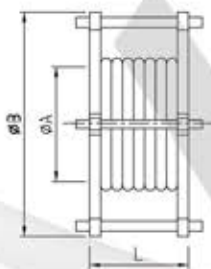

UNITS : mm

MODEL	A	B	L	COMPLIANCE
JF-050	50	155	150	LT-050
JF-065	65	175	150	LT-065
JF-080	80	185	150	LT-080
JF-100	100	210	150	LT-100
JF-125	125	250	150	LT-125
JF-150	150	280	150	LT-150
JF-200	200	330	200	LT-200
JF-250	250	400	200	LT-250
JF-300	300	445	200	LT-300
JF-350	350	490	230	LT-350
JF-400	400	560	230	LT-400

FLEXIBLE JOINT

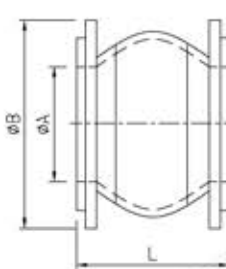

UNITS : mm

MODEL	A	B	L	COMPLIANCE
F-050	50	155	105	LT-050
F-065	65	175	115	LT-065
F-080	80	185	130	LT-080
F-100	100	210	135	LT-100
F-125	125	250	170	LT-125
F-150	150	280	180	LT-150
F-200	200	330	205	LT-200
F-250	250	400	240	LT-250
F-300	300	445	260	LT-300
F-350	350	490	265	LT-350
F-400	400	560	265	LT-400

Accessories

SUCTION SILENCER(SHORT)

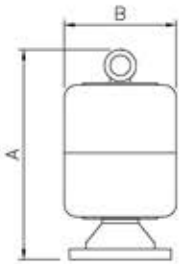

UNITS : mm

MODEL	A	B	COMPLIANCE
S-50	338	177	LT-50
S-65	338	177	LT-65

90° ELBOW

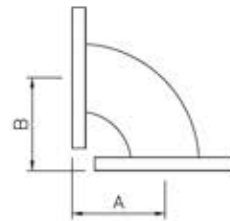

UNITS : mm

MODEL	A	B	COMPLIANCE
HE-050	84	159	LT-050
HE-065	105	105	LT-065
HE-080	122	122	LT-080
HE-100	160	160	LT-100
HE-125	199	199	LT-125
HE-150	237	237	LT-150
HE-200	313	313	LT-200
HE-250	389	389	LT-250
HE-300	465	465	LT-300
HE-350	541	541	LT-350
HE-400	618	618	LT-400

FILTER TANK

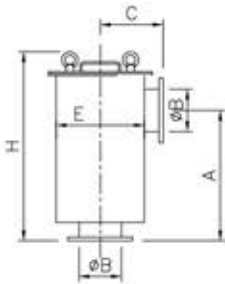

UNITS : mm

MODEL	A	B	C	E	H
B-050	393	50	184	216	557
B-065	395	65	186	216	559
B-080	480	80	225	263	679
B-100	480	100	210	263	679

FILTER TANK

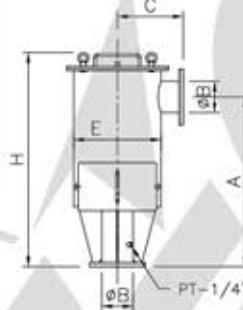

UNITS : mm

MODEL	A	B	C	E	H
B-125	758	125	296	392	958
B-150	760	150	298	392	960
B-200	920	200	370	492	1150
B-250	1092	250	345	492	1400
B-300	1200	300	420	612	1593
B-350	1298	350	515	777	1686
B-400	1298	400	515	777	1686

CHECK VALVE

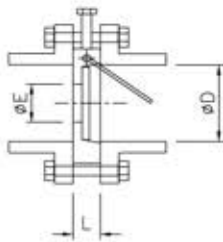

UNITS : mm

MODEL	A	B	C	COMPLIANCE
C-050	50	30	16	LT-050
C-065	65	45	18	LT-065
C-080	80	55	18	LT-080
C-100	100	70	18	LT-100
C-125	125	90	21	LT-125
C-150	150	110	22	LT-150
C-200	200	140	28	LT-200
C-250	250	190	28	LT-250

DUAL CHECK VALVE

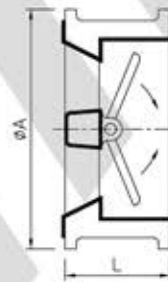

UNITS : mm

MODEL	A	B	COMPLIANCE
DC-200	270	127	LT-200
DC-250	332	146	LT-250
DC-300	377	181	LT-300
DC-350	420	184	LT-350
DC-400	483	191	LT-400

LIQUID FILLED PRESSURE GAUGE

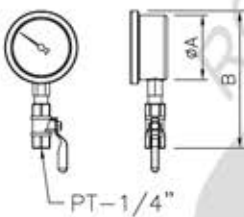

UNITS : mm

MODEL	A	B	COMPLIANCE
AC-A	63	129	LT-050-400

壓力範圍 76-0cmHg, 0-1kg/cm²

TUBE CONNECTOR

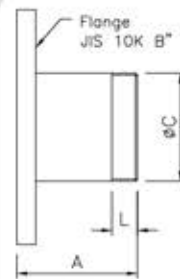

UNITS : mm

MODEL	A	B	C	L	COMPLIANCE
V-050	95	2"	50	40	LT-050
V-065	95	2.5"	65	40	LT-065
V-080	95	3"	80	40	LT-080
V-100	95	4"	100	40	LT-100
V-125	155	5"	125	50	LT-125
V-150	155	6"	150	50	LT-150
V-200	155	8"	200	60	LT-200
V-250	155	10"	250	60	LT-250
V-300	155	12"	300	60	LT-300
V-350	160	14"	350	70	LT-350
V-400	160	16"	400	70	LT-400

ABSORBER

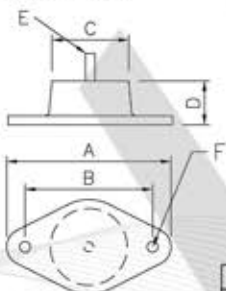

UNITS : mm

MODEL	A	B	C	D	E	F
UJ-200J	140	110	64	55	3/8"	φ14 0-150
UJ-500J	214	166	100	57	1/2"	φ14 140-450
UJ-800J	268	220	130	82	1/2"	φ17 400-750

ABSORBER

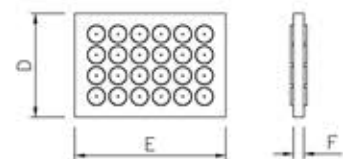
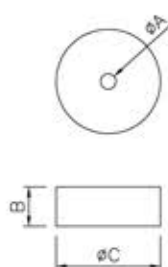

UNITS : mm

MODEL	A	B	C	D	E	F
LT-040	15	25	50			
LT-050-065	15	25	75			
LT-080-100	25	39	102			
LT-125-400				100	150	10

ROOTS TYPE BLOWER
LONGTECH

LONGTECH Machinery Industry Co. Ltd

No.23, Lane 470, Nanshan Rd., Sec. 2,
Luchu Distric, Taoyuan City, Taiwan R.O.C

TEL: 886-3-324-2370

FAX: 886-3-324-0219

<http://www.rootsblower.com.tw>

E-mail: aero-tech@umail.hinet.net